

Fall 1983

Comparative Review of Death Sentences: An Empirical Study of the Georgia Experience

David C. Baldus

Charles Pulaski

George Woodworth

Follow this and additional works at: <https://scholarlycommons.law.northwestern.edu/jclc>

 Part of the [Criminal Law Commons](#), [Criminology Commons](#), and the [Criminology and Criminal Justice Commons](#)

Recommended Citation

David C. Baldus, Charles Pulaski, George Woodworth, Comparative Review of Death Sentences: An Empirical Study of the Georgia Experience, 74 *J. Crim. L. & Criminology* 661 (1983)

This Symposium is brought to you for free and open access by Northwestern University School of Law Scholarly Commons. It has been accepted for inclusion in *Journal of Criminal Law and Criminology* by an authorized editor of Northwestern University School of Law Scholarly Commons.

COMPARATIVE REVIEW OF DEATH SENTENCES: AN EMPIRICAL STUDY OF THE GEORGIA EXPERIENCE*

DAVID C. BALDUS**
CHARLES PULASKI***
GEORGE WOODWORTH****

I. INTRODUCTION	663
A. THE CONCEPTS OF DISPROPORTIONALITY AND COMPARATIVE EXCESSIVENESS	665
B. DIFFERING APPROACHES TO THE APPELLATE REVIEW OF DEATH SENTENCES	668
C. METHODOLOGICAL ISSUES IN COMPARATIVE SENTENCE REIVEW	670
D. WHY STUDY GEORGIA?.....	672

* Funding for this research was provided by the National Institute of Justice (Grant 80-IJ-CX-0035), the Iowa Law School Foundation, the Edna McConnell Clark Foundation, the Center for Interdisciplinary Legal Studies, College of Law, Syracuse University, University of Iowa Graduate College, and Arizona State University College of Law.

We are grateful for the assistance provided by the staffs of the Georgia Department of Offender Rehabilitation and the Board and staff at the Georgia Department of Pardons and Paroles. We are particularly grateful for the assistance of Dr. Timothy Carr and Marsha Chalker Hopkins at the Department of Offender Rehabilitation and of Donnie Lee and Susan Aiken at the Board of Pardons and Paroles. We are also indebted to the staff of the Georgia Supreme Court, especially Joline B. Williams, the Clerk of the Court; the staff of the Georgia Department of Archives and History (which archives retired Georgia Supreme Court records); and the staff of the Department of Human Resources, especially William McWade, Michael R. Lavoie and Gilmer Chatham of the Vital Records Unit. We also want to acknowledge the valuable research assistance of law students at the University of Iowa and Syracuse University, particularly the contribution of Robert Rasmussen and Orry Korb. This study would not have been possible without the assistance and support of all these people.

** Professor of Law, University of Iowa College of Law. LL.M. Yale University, 1969; LL.B. Yale University, 1964; M.A. University of Pittsburgh, 1962; A.B. Dartmouth College, 1957.

*** Professor of Law, Arizona State University College of Law. LL.B. Yale University, 1967; B.A. Yale University, 1964.

**** Associate Professor of Statistics, University of Iowa. Ph.D. University of Minnesota, 1966; B.A. Carleton College, 1962.

II.	GEORGIA'S SYSTEM OF COMPARATIVE SENTENCE REVIEW	673
	A. THE UNIVERSE OF POTENTIALLY SIMILAR CASES	673
	B. REVIEW OF INDIVIDUAL DEATH CASES	675
	C. THE IDENTIFICATION OF SIMILAR CASES	675
III.	ISSUES AND METHODOLOGY	679
	A. THE ISSUES	679
	B. METHODOLOGY	679
	1. <i>The Data</i>	680
	2. <i>Measuring Comparative Excessiveness</i>	680
	a. Case specific measures of comparative excessiveness	680
	(1) <i>The salient factors method</i>	680
	(2) <i>The main determinants method</i>	684
	(3) <i>The index method</i>	689
	b. Systemwide measures of comparative excessiveness	692
	(1) <i>Legislative criteria measures</i>	693
	(2) <i>Regression-based scales</i>	694
	c. Evaluating excessiveness levels	695
IV.	THE RESULTS	698
	A. THE EVIDENCE OF COMPARATIVE EXCESSIVENESS IN GEORGIA'S POST- <i>FURMAN</i> DEATH-SENTENCING SYSTEM	698
	1. <i>Systemwide Measures</i>	698
	2. <i>Case Specific Measures</i>	703
	B. THE SOURCES OF COMPARATIVE EXCESSIVENESS	706
	C. COMPARATIVE SENTENCE REVIEW IN THE GEORGIA SUPREME COURT	710
	D. EVALUATION	712
	1. <i>The De Facto Review Hypothesis</i>	713
	2. <i>The Death Case Bias Hypothesis</i>	716
	3. <i>Possible Sources of Death Case Bias</i>	718
	a. A precedent-seeking approach to proportionality review	720
	b. The penalty trial requirement hypothesis	720
	c. Limited technology	723
	d. The Georgia court's universe of potentially similar cases	723
V.	CONCLUSION	728
	A. SUMMARY OF FINDINGS	728
	B. EIGHTH AMENDMENT IMPLICATIONS	730

C. THE FUTURE OF COMPARATIVE SENTENCE REVIEWS . 731

I. INTRODUCTION

Comparative sentence review—what the United States Supreme Court has sometimes described as “proportionality review”—is a procedure by which a court determines whether a death sentence is consistent with the usual pattern of sentencing decisions in similar cases or is comparatively excessive.¹ This procedure requires the reviewing court to identify other cases from the same jurisdiction that are “similar” in some pertinent respect to the death sentence case under review and to decide, in light of the sentences imposed in those other “similar” cases, whether the death sentence being scrutinized conforms to the constitutional standard of evenhanded, consistent sentencing in capital cases.² Legislation in more than twenty states requires the state supreme court to conduct some form of comparative sentence review in death sentence cases.³ For

¹ A death sentence is comparatively excessive if other defendants with similar characteristics generally receive sentences other than death for committing factually similar offenses in the same jurisdiction. Baldus, Pulaski, Woodworth & Kyle, *Identifying Comparatively Excessive Sentences of Death: A Quantitative Approach*, 33 STAN. L. REV. 1 (1980). The Georgia Supreme Court has referred to that component of its mandatory appellate review process which addresses the possible existence of comparative excessiveness as “comparative sentence review.” See *Ross v. State*, 233 Ga. 361, 211 S.E.2d 356 (1974), cert. denied, 428 U.S. 910 (1976). The United States Supreme Court has described the same procedure variously as “proportionality review,” “comparative review,” and “comparative proportionality review.” *Pulley v. Harris*, 52 U.S.L.W. 4141 (Jan. 23, 1984) (No. 82-1095). We prefer the term used by the Georgia court because it avoids any possible confusion between comparatively excessive death sentences and those which are unconstitutional because they are disproportionate to the offense committed. See *infra* text accompanying notes 12-29.

² The Court has referred to the constitutional requirement of evenhanded, consistent sentencing in capital cases on several occasions. See, e.g., *Zant v. Stephens*, 103 S. Ct. 2733, 2744 (1983); *Lockett v. Ohio*, 438 U.S. 586, 601 (1978) (plurality opinion); *Gardner v. Florida*, 430 U.S. 349, 361 (1977) (plurality opinion); *Jurek v. Texas*, 428 U.S. 262, 276 (1976) (plurality opinion); *Proffitt v. Florida*, 428 U.S. 242, 252-53 (1976) (plurality opinion); see also *Furman v. Georgia*, 408 U.S. 238, 398-99 (1972) (Burger, C.J., dissenting) (“The decisive grievance of the [concurring opinions of Justice Stewart and Justice White] . . . is that the present system of discretionary sentencing in capital cases has failed to produce evenhanded justice . . .”).

³ See, e.g., ALA. CODE tit. 13A, § 5-53 (b)(3) (1982); CONN. GEN. STAT. ANN. § 53a-46b (b)(3) (West Cum. Supp. 1982); DEL. CODE ANN. tit. 11, § 4209(g)(2)(a) (1979); KY. REV. STAT. ANN. § 532.075(3)(c) (Baldwin Supp. 1982); LA. CODE CRIM. PROC. ANN. art. 905.9 (West Supp. 1983); LA. SUP. CT. R. 28(1)(c); MD. ANN. CODE art. 27, § 414(e)(4) (1982); MISS. CODE ANN. § 99-19-105(3)(c) (Supp. 1982); MO. ANN. STAT. § 565.014.3(3) (Vernon 1979); MONT. CODE ANN. § 46-18-310(3) (1981); NEB. REV. STAT. § 29-2521.03 (1979) (review of sentences in all cases involving criminal homicide); NEV. REV. STAT. ANN. § 177.055 (2)(d) (1979); N.H. REV. STAT. ANN. § 630:5(VII)(c) (Supp. 1979); N.M. STAT. ANN. § 31-20A-4 C(4) (Supp. 1981); N.C. GEN. STAT. § 15A-2000(d)(2) (1978); OKLA. STAT. ANN. tit. 22, § 701.12(c)(3) (West Supp. 1980-1981); 18 PA. CONS. STAT. ANN. § 1311(h)(3)(iii) (Purdon Supp. 1980); S.C. CODE ANN. § 16-3-25(C)(3) (Supp. 1982); S.D. CODIFIED LAWS ANN. § 23A-27A-12(3) (1979); TENN. CODE ANN. § 39-2406(c)(4) (Supp. 1982); VA. CODE § 17-110.1(C)(2) (1982); WASH. REV. CODE ANN. § 10.94.030(3)(b) (1980); WYO. STAT. § 6-2-

example, in Georgia—whose statute has served as a model for a number of states—the supreme court determines whether each death sentence is “excessive or disproportionate to the penalty imposed in similar cases, considering both the crime and the defendant.”⁴ In a number of other jurisdictions state supreme courts conduct a “comparative proportionality review” in death cases even in the absence of legislation.⁵

Whether state supreme courts engage in some form of comparative sentence review in death penalty cases and the manner in which they do so may be of constitutional significance. The United States Supreme Court has suggested that “proportionality review” can be an important protection against arbitrary and capricious death sentences.⁶ On the other hand, in *Jurek v. Texas*, the Court sustained the constitutionality of a death-sentencing statute that did not provide any form of comparative sentence review.⁷ And more recently, the Court concluded in *Pulley v. Harris* that the California death-sentencing statute includes sufficient alternative safeguards to ensure evenhanded, consistent sentencing in capital cases despite the lack of comparative sentence review. The Court stated, however, that comparative sentence review could be constitutionally required if a capital sentencing system lacked other adequate checks on arbitrariness.⁸

What is clear, however, is that individual death sentences that are excessively severe in comparison to the sentences imposed in factually indistinguishable cases—what we call “comparatively excessive”—do violate the eighth amendment.⁹ Furthermore, in those states whose legislatures or courts have adopted the comparative sentence review process as a safeguard against arbitrary and capricious death sentences, the manner in which the state supreme court actually conducts that review process in a particular case may also have constitutional implications.¹⁰ Indeed, in *Zant v. Stephens*, the Court specifically based its decision rein-

103(d)(iii) (1977); *cf.* NEB. REV. STAT. § 29-2522(3) (1979) (one factor which judge or judges must consider prior to imposing sentence).

⁴ GA. CODE ANN. § 27-2537(c)(3) (1983).

⁵ *Proffitt v. Florida*, 428 U.S. at 258-59; *State v. Richmond*, 114 Ariz. 186, 196-97, 560 P.2d 41, 51 (1976)(en banc), *cert. denied*, 433 U.S. 915 (1977).

⁶ *See Pulley v. Harris*, 52 U.S.L.W. 4141 (Jan. 23, 1984) (No. 82-1095); *Zant v. Stephens*, 103 S. Ct. at 2742.

⁷ 428 U.S. 262 (1976). *But see Autrey v. Estelle*, 104 S. Ct. 24 (granting stay of execution), *motion to vacate stay denied*, 104 S. Ct. 326 (1983).

⁸ *Pulley v. Harris*, 52 U.S.L.W. 4141 (Jan. 23, 1984) (No. 82-1095).

⁹ *Godfrey v. Georgia*, 446 U.S. 420, 433 (1980) (plurality opinion) (death sentence invalid in a case that cannot be distinguished in any “principled way” from other life sentence cases); *see also supra* note 2.

¹⁰ *Godfrey v. Georgia*, 446 U.S. 420 (1980); *Presnell v. Georgia*, 439 U.S. 14 (1978); *cf. Hicks v. Oklahoma*, 447 U.S. 343 (1980) (denial of state-created procedural right violates due process).

stating a Georgia death sentence upon performance by the Georgia Supreme Court of a comparative sentence review which "we have also been assured" will result in the vacation of a comparatively excessive death sentence.¹¹

A. THE CONCEPTS OF DISPROPORTIONALITY AND COMPARATIVE EXCESSIVENESS

As a preliminary matter, it is useful to distinguish between death sentences that are "comparatively excessive" in light of the lesser sentences imposed in other comparable cases and death sentences that violate the eighth amendment because, in comparison to the offense committed, they are disproportionate. The concept of disproportionality traditionally employed in eighth amendment jurisprudence contemplates a judicial judgment, informed by the values of the court and by such indicia of contemporary community standards as legislative enactments and jury decisions, that a given sanction is a disproportionate and excessive punishment for a particular offense.¹² Because the eighth amendment's underlying concern is preventing the "purposeless and needless imposition of pain and suffering," it condemns penal sanctions whose severity or length serve no legitimate social purpose either as a deterrent or as a form of justifiable retribution.¹³

The United States Supreme Court has invoked the eighth amendment's prohibition of disproportionate punishments to invalidate death sentences in two cases. In *Coker v. Georgia*, the Court ruled that death was a "grossly disproportionate and excessive punishment" for the rape of an adult.¹⁴ More recently, in *Enmund v. Florida*, the Court held that death was a disproportionate sanction when imposed upon an accessory to a robbery who was convicted of capital murder solely by means of the felony-murder doctrine.¹⁵ On the other hand, in *Gregg v. Georgia*, the Court held that death was a permissible sanction in cases involving intentional, aggravated murder.¹⁶ In each of these cases the Court decided the disproportionality question by considering two basic factors: first, whether the punishment of death, society's harshest and most irrevocable sanction, comported with the heinousness of the offense; and, second, whether recent legislative authorization and judicial imposition of the death penalty in such cases occurred with sufficient frequency to be

¹¹ *Zant v. Stephens*, 103 S. Ct. at 2750.

¹² *Enmund v. Florida*, 102 S. Ct. 3368, 3372 (1982) (plurality opinion).

¹³ *Coker v. Georgia*, 433 U.S. 584, 592 (1977) (plurality opinion).

¹⁴ *Id.*

¹⁵ See *supra* note 12.

¹⁶ 428 U.S. at 176-87.

consistent with contemporary community standards.¹⁷

Analytically distinct from this traditional notion of constitutional disproportionality is the concept of comparative excessiveness, with which we are particularly concerned. Issues of comparative excessiveness arise in cases in which the defendant's death sentence is not disproportionate in the traditional eighth amendment sense, given the nature of his crime and the circumstances of his case. Imposing a death sentence upon such a defendant may, nevertheless, violate the eighth amendment if defendants convicted of the same offense in other, factually similar cases ordinarily receive lesser sentences.¹⁸ Under these circumstances, a death sentence would be comparatively excessive because it is disproportionate to the penalties generally imposed on other defendants whose cases cannot be meaningfully distinguished.¹⁹ Because the process of comparative sentence review requires the reviewing court to evaluate the propriety of a particular death sentence in light of the sentences imposed in other similar cases, it is a major safeguard, at least in theory, against comparatively excessive death sentences.²⁰

The concept of comparative excessiveness differs from the more traditional notion of disproportionality in at least two important respects. First, disproportionality in the traditional sense directly addresses whether a given sanction is constitutionally excessive because it serves no useful social purpose,²¹ while comparative excessiveness approaches the same ultimate question from the perspective of evenhandedness.²² The prohibition of comparatively excessive death

¹⁷ *Enmund v. Florida*, 102 S. Ct. at 3372-79; *Coker v. Georgia*, 433 U.S. at 591-600; *Gregg v. Georgia*, 428 U.S. at 173, 176-87.

¹⁸ See *Baldus, Pulaski, Woodworth & Kyle*, *supra* note 1, at 1-17. For lower court decisions acknowledging the eighth amendment's prohibition of comparatively excessive death sentences see, e.g., *Williams v. Maggio*, 679 F.2d 381 (5th Cir. 1982), *cert. denied*, 103 S. Ct. 3553 (1983); *Gray v. Lucas*, 677 F.2d 1086 (5th Cir. 1982); *Henry v. Wainwright*, 661 F.2d 56 (5th Cir.), *cert. granted*, 102 S. Ct. 2922 (1982); *Smith v. Balkcom*, 660 F.2d 573, 585-86 (5th Cir. 1981), *modified*, 671 F.2d 858 (5th Cir.), *cert. denied*, 103 S. Ct. 181 (1982); *Blake v. Zant*, 513 F. Supp. at 812.

¹⁹ *Godfrey v. Georgia*, 466 U.S. at 433.

²⁰ See *Baldus, Pulaski, Woodworth & Kyle*, *supra* note 1, at 20-21; see also *Zant v. Stephens*, 103 S. Ct. at 2749.

²¹ *Coker v. Georgia*, 433 U.S. at 592.

²² This perspective is dictated by the concerns expressed in *Furman v. Georgia*, 408 U.S. 238 (1972), which the Court subsequently described as condemning capital sentencing procedures that do not minimize the risk of "arbitrary and capricious" death sentences. *Zant v. Stephens*, 103 S. Ct. at 2741; *Gregg v. Georgia*, 428 U.S. at 188 (plurality opinion); see also *Godfrey v. Georgia*, 446 U.S. 420 (1980). In *Gregg*, the plurality opinion also commented:

The provision for appellate review in the Georgia capital-sentencing system serves as a check against the random or arbitrary imposition of the death penalty. In particular, the proportionality review substantially eliminates the possibility that a person will be sentenced to die by the action of an aberrant jury. If a time comes when juries generally do not impose the death sentence in a certain kind of murder case, the appellate review

sentences thus contributes to the rational and consistent administration of justice in capital cases.²³ Indeed, it is for this reason that the Supreme Court condemned the death sentence imposed in *Godfrey v. Georgia*, a domestic slaying case: "There is no principled way to distinguish this case in which the death sentence was imposed, from the many cases in which it was not."²⁴ Furthermore, preventing comparatively excessive death sentences also ensures that those death sentences that are imposed are consistent with contemporary community standards, an important eighth amendment concern.²⁵

The second way in which the traditional notion of disproportionality and the concept of comparative excessiveness differ is the manner in which courts conduct each type of inquiry. The Supreme Court has repeatedly emphasized that determinations of disproportionality in the traditional sense are ultimately judicial judgments.²⁶ Legislative enactments, prior sentencing patterns, even public opinion surveys are important considerations, but ultimately the Justices themselves must assess the severity of the sanction in comparison to the gravity of the offense. By contrast, prior sentencing patterns assume much greater importance when one decides whether a particular death sentence is comparatively excessive. Indeed, the sentences imposed in factually similar cases provide the benchmark by which courts decide whether a particular death sentence is excessive or evenhanded when they engage in the process of true comparative sentence review.²⁷

Thus, although both traditional disproportionality analysis and the comparative excessiveness inquiry reflect a concern with sentencing patterns in similar cases, the degree of importance that each attributes to such patterns differs substantially. Additionally, when engaging in disproportionality analysis, the Court has freely considered sentencing patterns in similar cases on a nationwide basis.²⁸ Determinations of comparative excessiveness, by contrast, characteristically limit themselves to statewide sentencing patterns. For instance, Georgia's test is whether "juries generally throughout the state have imposed the death

procedures assure that no defendant convicted under such circumstances will suffer a sentence of death.

428 U.S. at 206.

²³ *Proffitt v. Florida*, 428 U.S. at 258-59.

²⁴ 446 U.S. at 433; *see also Zant v. Stephens*, 103 S. Ct. at 2749-50 (decision based in part on Georgia Supreme Court's mandatory appellate review which will serve to vacate a death sentence "if it is excessive or substantially disproportionate to the penalties that have been imposed under similar circumstances").

²⁵ *Witherspoon v. Illinois*, 391 U.S. 510, 519 n.15 (1968); *see Baldus, Pulaski, Woodworth & Kyle, supra* note 1, at 18 n.64.

²⁶ *See supra* text accompanying notes 11-16.

²⁷ *See Zant v. Stephens*, 103 S. Ct. at 2742.

²⁸ *See supra* text accompanying note 17.

penalty" in similar cases,²⁹ although Louisiana uses a more restrictive, circuitwide standard.³⁰

B. DIFFERING APPROACHES TO THE APPELLATE REVIEW OF DEATH SENTENCES

The differences in judicial method that courts employ when deciding traditional claims of disproportionality and when scrutinizing a death sentence for comparative excessiveness underscore an important observation. Courts can review death sentence cases, either as a constitutional matter or pursuant to statutory procedure, in a variety of ways, not all of which will include a true comparative sentence review. For example, there are cases in which state supreme courts have purported to decide whether a particular death sentence was excessive or disproportionate on the basis of generalized notions of reasonableness.³¹ They make this determination by weighing the aggravating and mitigating circumstances of the particular case under review, and by deciding whether, under those circumstances, death appears to be a reasonably appropriate sanction. In making this judgment the court will rely on its own values, experience, and general familiarity with prior cases; this approach requires no explicit reference to any governing criteria and involves no reference to the sentences imposed in other cases.

A more formal version of this "reasonableness" approach might be called the "precedent-seeking" approach.³² Here the court actually identifies the relevant aggravating and mitigating factors and makes a judgment on that basis as to the appropriateness of the death sentence under review. In addition, however, the court also identifies one or more prior cases which it regards as comparable to the case on appeal, and which it cites as support for its decision to affirm or to vacate the death sentence. Thus, if the court concludes that the death sentence under review is reasonably appropriate, it will cite one or more "similar" cases that also resulted in death sentences.³³ Conversely, if the court

²⁹ *Jarrell v. State*, 234 Ga. 410, 425, 216 S.E.2d 258, 270 (1975), *cert. denied*, 428 U.S. 910 (1976), *quoted in* *Gregg v. Georgia*, 428 U.S. at 205.

³⁰ LA. SUP. CT. R. 28 § 1(c). The Fifth Circuit recently sustained the constitutionality of Louisiana's judicial circuit wide form of proportionality review in *Williams v. Maggio*, 679 F.2d 381 (5th Cir. 1982), *cert. denied*, 103 S. Ct. 3553 (1983); *see also* *Maggio v. Williams*, 104 S. Ct. 311 (1983) (order vacating stay of execution).

³¹ In essence, this review process involves a *de novo* determination of the sentencing authority's decision that the circumstances of the case being reviewed warrant imposition of the death penalty. *See, e.g.*, *Huckaby v. State*, 343 So. 2d 29 (Fla.), *cert. denied*, 434 U.S. 920 (1977), *Chambers v. State*, 339 So. 2d 204 (Fla. 1976); *State v. Dixon*, 283 So. 2d 1 (Fla. 1973), *cert. denied*, 416 U.S. 943 (1974).

³² *See* Baldus, Pulaski, Woodworth & Kyle, *supra* note 1, at 1 n.1.

³³ *Id.* Interestingly, in *McCaskill v. State*, 344 So. 2d 1276, 1280 (Fla. 1977), the Florida Supreme Court noted that the "precedent-seeking" approach—which that court itself some-

considers the death sentence under review to be unreasonable or inappropriate, it will cite a group of "similar" life sentence cases to support its decision to vacate the death sentence as excessive or disproportionate.³⁴

In contrast to both the generalized "reasonableness" approach and the "precedent-seeking" approach, a true comparative sentence review employs a "frequency" approach, consisting of three steps.³⁵ First, the court decides which features of the death sentence case under review will govern the selection of other cases as "similar." Second, using those criteria, the court identifies those other "similar" cases and determines the frequency with which defendants received death sentences in those similar cases. Finally, the court decides whether death sentences were imposed so infrequently in this class of similar cases as to make imposition of the death penalty in the case under review comparatively excessive. In making this judgment, the court must consider with what regularity death sentences must be imposed in an identifiable class of cases either to serve as an effective deterrent to others or to constitute a justifiable form of retribution in light of contemporary community standards.³⁶

As the foregoing discussion indicates, there are certain similarities between the "precedent-seeking" form of appellate review and the "frequency" approach characteristic of a true comparative sentence review. Furthermore, the "precedent-seeking" approach can, on occasion, identify death sentences that are comparatively excessive. The difference between the two methods, however, deserves emphasis. They both require the reviewing court to scan prior cases and to evaluate the death sentence under review on the basis of the sentences imposed in prior cases regarded as comparable. A "precedent-seeking" court, however, will be satisfied upon finding one or two prior cases, the circumstances of which make them suitable benchmarks for the death sentence on appeal. By contrast, the "frequency" approach requires a survey of the sentencing results in all prior cases deemed to be similar to the case on appeal because it is the frequency with which life sentences result in that entire class of cases that determines whether the death sentence on appeal is excessive or evenhanded. For this reason, while a "precedent-seeking"

times employs, *see supra* note 32—is probably constitutionally deficient as a safeguard against comparatively excessive death sentences.

³⁴ *See, e.g.*, *Blake v. Zant*, 513 F. Supp. at 815-18.

³⁵ *See* *Baldus, Pulaski, Woodworth & Kyle, supra* note 1, at 16, 22.

³⁶ In *Furman v. Georgia*, Justice White suggested that regularity in the imposition of death sentences must be judged on the basis of these criteria. 408 U.S. at 311-12 (White, J., concurring); *see also* *Gregg v. Georgia*, 428 U.S. at 222-24 (White, J., concurring). More recently, a majority of the Court appears to have joined in Justice White's approach. *See* *Enmund v. Florida*, 102 S. Ct. at 3377-79.

approach may be a useful tool for deciding whether a given death sentence is disproportionate in the traditional sense, only a true comparative sentence review, utilizing the "frequency" approach, can adequately address the question of comparative excessiveness.

C. METHODOLOGICAL ISSUES IN COMPARATIVE SENTENCE REVIEW

Once a court decides to engage in comparative sentence review, it must resolve a series of preliminary questions. To begin with, the court must decide what group of cases it will examine in search for those cases that are "similar" to the death sentence case under review. We call this group of cases the universe of potentially similar cases. In other words, the court must begin its search for "similar" cases by deciding what the limits of that search will be.

In connection with this decision, certain guiding principles do exist. Clearly, for example, the universe of potentially similar cases should include all recent cases from the reviewing court's jurisdiction³⁷ in which the sentencing authority actually decided whether to impose a death sentence. Although some state supreme courts sometimes limit their review of comparable cases to those cases in which the defendants only received death sentences,³⁸ such a restriction is flatly inconsistent with the entire purpose of comparing sentences; it reduces the review process to a "precedent-seeking" exercise, with all the deficiencies that approach entails.

Other parameters of the universe of potentially similar cases are less clear-cut. For example, should the reviewing court only examine cases arising under the current capital sentencing statute or can it properly include cases arising under the pre-1972 sentencing procedures condemned in *Furman v. Georgia*?³⁹ Another question is what procedural stages the universe of potentially similar cases should include. One pos-

³⁷ Arguably, one could include factually similar cases from other jurisdictions in this universe, as is the United States Supreme Court's custom when engaging in traditional disproportionality analysis. *See supra* text accompanying notes 28-30. However, the Court has given no indication that determinations of comparative excessiveness should be governed by interstate standards. On the contrary, it sustained the Georgia, Florida and Texas statutes in 1976 in part because each required appellate review by a court with statewide jurisdiction. *See* *Gregg v. Georgia*, 428 U.S. at 198; *Proffitt v. Florida*, 428 U.S. at 259-60; *Jurek v. Texas*, 428 U.S. at 276; *see also supra* note 22.

³⁸ *See, e.g.*, *Williams v. Indiana*, — Ind. —, 430 N.E.2d 759, 764, *appeal dismissed*, 103 S. Ct. 33 (1982); *Provence v. State*, 337 So. 2d 783 (Fla. 1976), *cert. denied*, 431 U.S. 969 (1977); *see also supra* note 33.

³⁹ In *Gregg*, the United States Supreme Court concluded that using pre-*Furman* cases for comparative purposes "was necessary at the inception of the new procedure" and was, therefore, constitutionally permissible. 428 U.S. at 204 n.56. Whether using cases decided under a different sentencing procedure is methodologically sound, however, presents a different question.

sibility is that it should only include cases in which the sentencing authority actually decided what sentence to impose. Another alternative is that it should also include cases in which the jury convicted the defendant of a lesser offense or in which the prosecutor did not seek a death sentence, as part of a plea bargain or otherwise.⁴⁰

Another important methodological question concerns the status of potentially similar capital cases that resulted in convictions which, for one reason or another, the defendants never appealed.⁴¹ Identifying and securing adequate information about such cases can entail enormous practical difficulties; it is much easier to limit the universe of potentially similar cases to appealed cases, for which records already exist in the court's own files. However, since unappealed capital cases virtually always involve lesser sentences than death, a failure to include them in the universe of potentially similar cases can bias the ultimate determination of comparative excessiveness to the defendant's disadvantage.

Even after one has resolved the methodological issues concerning the universe of potentially similar cases, other issues remain. A principal question concerning the conduct of comparative sentence review involves selecting those features of the death sentence case under review that will serve to identify other cases as "similar." There seem to be two major approaches. The first is to select similar cases using a limited number of fact-specific criteria. Thus, a court might conclude that the relevant aggravating and mitigating features of a particular case were as follows: (a) the defendant killed one victim, (b) in the course of an armed robbery, (c) without any apparent provocation by the victim, and (d) the defendant has no prior criminal record. When identifying other cases as "similar" to such a case using a fact-specific approach, the court would look for other cases with these same factual characteristics.

The second basic approach is to estimate the overall culpability of each case in the universe of potentially similar cases, ideally in quantifiable form, and to rank each case in terms of its relative culpability level. One then selects as similar to the case under review other cases of comparable overall culpability. This approach requires the court to balance the aggravating and mitigating features of each case in the universe of similar cases when assessing its overall culpability. For example, when conducting a comparative sentence review of a death case involving two victims but no other special aggravating circumstances, a court might view as equally culpable another case involving one victim, an elderly

⁴⁰ For example, see the majority opinion and Justice Seiler's dissent in *State v. Mercer*, 618 S.W.2d 1 (Mo.) (en banc), *cert. denied*, 454 U.S. 933 (1981).

⁴¹ See Baldus, Pulaski, Woodworth & Kyle, *supra* note 1, at 4 n.13.

person, whose life the defendant had taken in a prolonged and unnecessarily painful manner.

D. WHY STUDY GEORGIA?

In order to test the efficacy of an operating system of comparative sentence review, we selected that of the Georgia Supreme Court for several reasons. First, the Georgia statute has served as a model for many other states. Second, in *Gregg v. Georgia*, in the course of deciding that the Georgia statute was constitutional on its face, the United States Supreme Court repeatedly stressed the requirement of a comparative sentence review in every death penalty case as a means of preventing arbitrary, capricious, or discriminatory death sentences.⁴² Third, because the Georgia statute has operated for a substantial period of time and because both homicides and capital convictions occur in that state with relative frequency, it offered sufficiently numerous data to permit the use of statistical tools. Lastly, and most importantly, Georgia offered us an opportunity to evaluate the significance, if any, of the differences between the manner in which the United States Supreme Court in *Gregg* assumed the Georgia statute would operate and what has actually occurred.

That such differences do exist is beyond dispute. In *Gregg* the Court presumed that juries would choose to impose the death penalty in every case in which a statutory aggravating circumstance was present and the evidence seemed to merit such a penalty.⁴³ In fact, however, no such uniformity of treatment has occurred. Although Georgia juries impose the death penalty at a relatively frequent rate in most cases in which penalty trials occur, there are many, many cases in which defendants who are guilty of equally aggravated crimes escape the possibility of a jury-imposed death sentence through prosecutorial intervention. This fact alone introduces a confound into the Georgia system that underscores the necessity in practice for an effective and consistent system of comparative sentence review.

II. GEORGIA'S SYSTEM OF COMPARATIVE SENTENCE REVIEW

Georgia's statute requires the state supreme court to determine whether each death sentence is "excessive or disproportionate to the penalty imposed in similar cases, considering both the crime and the

⁴² 428 U.S. at 198, 204-07; *id.* at 223-24 (White, J., concurring); *see also* *Zant v. Stephens*, 103 S. Ct. at 2742, 2750.

⁴³ *Id.* at 196-99 (plurality opinion); *id.* at 224-26 (White, J., concurring); *see also infra* note 56.

defendant."⁴⁴ When performing this task, the court customarily includes in its opinion an appendix listing the names and citations of the other cases deemed to be "similar" which support its ruling regarding the proportionality of the death sentence being reviewed.⁴⁵ To assist the court in selecting similar cases, the Georgia statute requires the trial judge in each death case to complete a standardized questionnaire prepared and supplied by the Georgia Supreme Court.⁴⁶ In addition, the statute authorizes the appointment of an "Assistant to the Supreme Court" whose functions include accumulating the records of "all capital felony cases in which sentence was imposed after January 1, 1970, or such earlier date as the Court may deem appropriate."⁴⁷ The statute requires this Assistant to provide the court with whatever information it desires with respect to each of these prior cases, "including but not limited to a synopsis or brief of the facts in the record concerning the crime and the defendant."⁴⁸ During the post-*Furman* period covered by this study, 1973-78, a principal function of this Assistant was to receive and to file the questionnaire sent to the court in each death case.⁴⁹ In addition, the Assistant prepared for the court's use a brief synopsis of every appealed capital murder case decided after January 1, 1970, whether or not it resulted in a death sentence.⁵⁰

A. THE UNIVERSE OF POTENTIALLY SIMILAR CASES

The Georgia statute does not explicitly define the universe of cases from which the court is to select "similar" cases when conducting a comparative sentence review. The statute does suggest, however, that this universe of potentially similar cases should include all murder convictions in which sentence was imposed after January 1, 1970.⁵¹ In practice, the court limits its search to post-1969 murder cases in which the defendant took an appeal.⁵² Because the Georgia Supreme Court al-

⁴⁴ GA. CODE ANN. § 27-2537(c)(3) (1983).

⁴⁵ GA. CODE ANN. § 27-2537(e) (1983) states that: "The court shall include in its decision a reference to those similar cases which it took into consideration."

⁴⁶ GA. CODE ANN. § 27-2537(a) (1983).

⁴⁷ GA. CODE ANN. § 27-2537(f) (1983).

⁴⁸ *Id.*

⁴⁹ Deposition of Dennis York, Esq., former Assistant for Proportionality Review, Nov. 13, 1978, in *House v. Balkcom*, No. C78-1417A, at 13 (N.D. Ga. filed Nov. 15, 1978) [hereinafter cited as *York Deposition 1978*].

⁵⁰ *Id.* at 34-36, 47-49.

⁵¹ GA. CODE ANN. § 27-2537(f) (1983) states that: "The Court shall accumulate the records of all capital felony cases in which sentence was imposed after January 1, 1970, or such earlier date as the court may deem appropriate."

⁵² The Georgia Supreme Court has defended the policy of considering only appealed cases on the ground that the appealed cases "represent a sufficient cross section of similar cases upon which an adequate comparative review can be made." *Ross v. State*, 233 Ga. 361, 365-66, 211 S.E.2d 356, 359 (1974), *cert. denied*, 428 U.S. 910 (1976). The United States

ways reviews death penalty cases, one consequence of this policy is that the universe of potentially similar cases includes all death sentence cases⁵³ but excludes life sentence cases which do not result in appeals. It is also the court's practice to include in the universe of potentially similar cases death sentence cases in which the court never conducted a comparative sentence review because it reversed the conviction or vacated the death sentence on unrelated grounds.⁵⁴

Some of the Georgia Supreme Court's opinions also suggest that its universe of potentially similar post-*Furman* cases includes only those cases in which a penalty trial occurred and the jury actually decided whether to impose a life or death sentence.⁵⁵ Such a requirement would, of course, exclude from the universe of potentially similar cases every capital case in which a convicted defendant avoided the death penalty because, as part of a plea bargain or otherwise, the prosecutor declined to seek a penalty trial.⁵⁶ The impact of such a requirement would be enormous. In actual practice approximately two-thirds of the defendants in our study who were convicted of murder after a jury trial received an automatic life sentence without the participation of the jury because either the prosecutor waived the trial or the judge took the issue from the jury.⁵⁷

Supreme Court approved of this policy in *Gregg v. Georgia*, 428 U.S. at 204 n.56 (1976) ("The Georgia court has the authority to consider [unappealed] cases . . .").

⁵³ In our sample of 113 death sentences, four cases involved no appeal in part because the trial court vacated the jury's death sentence.

⁵⁴ The Georgia Supreme Court has never addressed the propriety of this practice in any reported opinion so far as we know.

⁵⁵ The possibility that some justices may have applied such a policy is suggested by such decisions as *Goodwin v. State*, 236 Ga. 339, 345, 223 S.E.2d 703, 707 (1976) ("not unusual for juries in Georgia to impose the death penalty"); *Pryor v. State*, 238 Ga. 698, 708, 234 S.E.2d 918, 927 (1977) ("diverse juries in widely separated counties . . . have imposed the death penalty"); *Tucker v. State*, 244 Ga. 721, 732-38, 261 S.E.2d 635, 643 (1979) ("juries have given the death penalty"); *Jarrell v. State*, 234 Ga. 410, 425, 216 S.E.2d 258, 270 (1975), *cert. denied*, 428 U.S. 910 (1976) ("juries generally throughout the state"). A formal penalty trial requirement for inclusion in the universe of potentially similar cases exists in other jurisdictions. *See, e.g.*, *State v. Mercer*, 618 S.W.2d at 11, 20-21 (Seiler, J., dissenting).

⁵⁶ When a defendant has pled guilty to murder, GA. CODE ANN. § 27-2528 gives the judge the discretion to impose a life or death sentence after a penalty trial and § 27-2503(b) provides that when a jury convicts a defendant of murder "the court shall resume the trial and conduct a pre-sentence hearing before the jury and the judge will enter sentence as recommended by the jury." Although these statutory sections suggest that a penalty trial is mandatory when a defendant is convicted of murder, especially if convicted by a jury, in practice there is no penalty trial if the prosecutor does not affirmatively seek it, and the defendant receives an automatic life sentence.

⁵⁷ The trial transcripts of appealed cases are sometimes unclear whether the prosecutor unilaterally waived the death sentence, the trial judge decided not to conduct a penalty trial, or the prosecutor and the judge jointly decided not to hold a penalty trial.

B. REVIEW OF INDIVIDUAL DEATH CASES

Apparently, the Georgia Supreme Court's practice is to assign the identification of similar cases in any death sentence case to the "author judge" assigned to write the court's opinion.⁵⁸ This practice may explain the various approaches to comparative sentence review reflected in the court's opinions.⁵⁹ In some cases, in connection with this task, the author judge may request the court's Assistant for Proportionality Review to provide summaries of cases with the characteristics specified by the author judge. The Assistant for Proportionality Review performs this task by manually searching through the more than 700 cases for which summaries have been prepared.⁶⁰ However, the Assistant's deposition concerning the court's practices during the period covered by this study suggests that such requests for assistance in finding "similar cases" were infrequent. Apparently, in a large number of cases the author judges relied principally upon their own records and memory of prior decisions when identifying similar cases.⁶¹

C. THE IDENTIFICATION OF SIMILAR CASES

The opinions of the Georgia Supreme Court reveal no common method for selecting the characteristics of the death sentence case under review used for choosing "similar" cases. In many opinions the methodology is not disclosed; the court simply states that it compared the review case with the evidence and sentence in similar cases, and that those listed in the appendix support the determination that the death sentence under review is not disproportionate or excessive.⁶²

Other Georgia Supreme Court opinions indicate that the court, or the author judge, used a fact-specific approach to selecting similar cases. Less frequently, however, does such an opinion identify the specific factors employed. For example, in *Legare v. State*,⁶³ the court concluded that the defendant's death sentence was not excessive or disproportionate. It prefaced that determination with the following summary of the facts of the case: The defendant "broke into the victim's home, ran-

⁵⁸ York Deposition 1978, *supra* note 49, at 39. Neither the deposition nor the court's opinions indicate the role of the court as a body in resolving comparative sentence review issues.

⁵⁹ The principal variation observed is the procedure used to select the facts of the death sentence case under review used to identify similar cases. For further discussion, see *infra* text accompanying notes 62-77.

⁶⁰ York Deposition 1978, *supra* note 49, at 50-54.

⁶¹ Deposition of Dennis York, Esq., former Assistant for Proportionality Review, May 14, 1979, in *McCorquodale v. Balkcom*, No. C 79-95A, at 26-27, 34-35 (N.D. Ga. filed May 17, 1979) [hereinafter cited as York Deposition 1979].

⁶² *See, e.g.*, *Godfrey v. State*, 243 Ga. 302, 311, 253 S.E.2d 710, 718 (1979); *Alderman v. State*, 241 Ga. 496, 512, 246 S.E.2d 642, 652, *cert. denied*, 439 U.S. 999 (1978).

⁶³ 243 Ga. 744, 257 S.E.2d 247, *cert. denied*, 444 U.S. 984 (1979).

sacked it, and lay in wait for the victim's return, brutally beat him to death, took his automobile and made his getaway."⁶⁴ But at no point does the *Legare* opinion identify which of these facts, if any, the court employed when selecting the "similar" cases listed in the appendix for comparative purposes. Thus, any one or more of the following five features could be relevant:

- (1) the place of the crime and the defendant's mode of entry,
- (2) premeditation and lying in wait,
- (3) a contemporaneous crime—burglary,
- (4) a brutal, painful method of killing, or
- (5) commission of a subsequent crime by the defendant.⁶⁵

Lastly, a number of Georgia Supreme Court opinions are relatively informative about the salient features of the death sentence case being reviewed which the court employed to select other "similar" cases. Sometimes the court describes these features in terms of the statutory aggravating circumstances involved in the case, such as a contemporaneous capital felony,⁶⁶ for example, or a homicide committed for monetary gain.⁶⁷ More commonly, however, the court describes the salient factors used for selecting similar cases in a more fact-specific manner. Examples include references to the invasion of a home and an execution-style murder in which the defendant was the prime mover,⁶⁸ to a robbery or burglary of a victim's home;⁶⁹ to the callous, intentional, methodical murder of a helpless kidnap victim;⁷⁰ or to the victim's status as a robbery witness.⁷¹

When the Georgia Supreme Court does identify the factual circumstances used for selecting similar cases, mitigating factors appear to play only a minor role. Occasionally, the court will include a mitigating circumstance among the criteria used for selecting similar cases.⁷² Usually,

⁶⁴ *Id.* at 759, 257 S.E.2d at 257.

⁶⁵ An analysis of the factual patterns of the 18 cases cited by the court as similar indicates that the only characteristic shared by all of these cases was the presence of a contemporaneous felony (although in two of the cases the only contemporaneous crime was another murder). Also, all but two of the cases involved a brutal killing (stabbing, beating, strangulation) or an execution-style murder, and most of the cases involved victims who were middle-aged or older. All but two of the 18 cases involved multiple victims.

⁶⁶ *Gates v. State*, 244 Ga. 587, 600, 261 S.E.2d 349, 358 (1979), *cert. denied*, 445 U.S. 938 (1980).

⁶⁷ *Douthit v. State*, 239 Ga. 81, 90, 235 S.E.2d 493, 499-500 (1977), *cert. denied*, 445 U.S. 938 (1980).

⁶⁸ *Hill v. State*, 237 Ga. 794, 802-03, 229 S.E.2d 737, 743 (1976).

⁶⁹ *Moore v. State*, 233 Ga. 861, 865-66, 213 S.E.2d 829, 833 (1975), *cert. denied*, 428 U.S. 910 (1976).

⁷⁰ *Tucker v. State*, 245 Ga. 68, 78, 263 S.E.2d 109, 113, *cert. denied*, 449 U.S. 891 (1980).

⁷¹ *Tamplin v. State*, 235 Ga. 20, 27, 218 S.E.2d 779, 784, *modified on other grounds*, 235 Ga. 774, 221 S.E.2d 455 (1975).

⁷² *Hawes v. State*, 240 Ga. 327, 341, 240 S.E.2d 833, 842 (1977) (Hill, J., concurring).

however, the court only discusses mitigating factors when explaining why the mitigating circumstances invoked by a defendant are insufficient to distinguish his case from other cases in which death sentences were imposed.⁷³

Although no Georgia Supreme Court opinion indicates that the court has ever employed an overall culpability method for selecting comparable cases, there is some evidence of its use. An analysis of the factual circumstances of cases that the court identifies as "similar" in its appendices suggests that the court sometimes selects as "similar" cases that are factually quite different from the death sentence case under review. Presumably, therefore, the court selected these cases because it regards the defendant on appeal and those in the "similar" cases as comparable in terms of relative culpability.

A possible example of the overall culpability method at work is Case 495.⁷⁴ Before committing the murder for which the jury sentenced him to death, Defendant 495 shot another person; then, without provocation he shot and killed the victim, a defenseless stranger who had responded to the defendant's request for assistance; later, in an effort to avoid arrest, the defendant engaged in a shoot-out with the police. In ruling that Defendant 495's death sentence was not disproportionate, the Georgia Supreme Court cited fourteen "similar" death sentence cases,⁷⁵ six of which involved facts that were clearly more aggravated

One explanation for the infrequent reference to mitigating circumstances may be the policy of the Assistant for Proportionality Review during the period of this study not to include all mitigating circumstances in his case summaries. York Deposition 1978, *supra* note 49, at 43.

⁷³ *Tucker v. State*, 244 Ga. at 732-33, 261 S.E.2d at 643; *Bowen v. State*, 241 Ga. 492, 495-96, 246 S.E.2d 322, 324-25 (1978). *Tucker* suggests that a mitigating circumstance in a death sentence case will not distinguish it from other "similar" death sentence cases if juries have given a death sentence in other cases in which that mitigating feature was also present.

⁷⁴ *Case 495-Death Sentence Case Under Review*. The 30-year-old male defendant, diagnosed as a paranoid schizophrenic, kidnapped the victim who had been lured from his house to aid another whom the defendant had wounded. Without provocation, the defendant shot the victim as he pled for his life and took his personal belongings. The defendant was then arrested after a shoot-out with the police.

⁷⁵ *APPENDIX CASES:*

Case 074

The defendant bound and killed two victims in their home while committing robbery. He was later characterized as depraved of mind after laughing about the murders.

Case 576

With premeditation, the defendant bound, strangled, tortured, and robbed two elderly victims, both of whom died.

Case 551

The defendant sexually tortured, mutilated and killed a woman he forcefully brought home from a bar. Motive: "To teach that 'nigger-lover' a lesson."

Case 571

While on a crime spree, the defendant beat, robbed, and killed three elderly victims in their homes.

because of the number of victims or the level of violence and cruelty.⁷⁶ Many of the other cases cited as “similar” were factually quite different. However, after weighing the aggravating factors in these appendix cases, especially the level of pain inflicted, against the mitigating factors, one could reasonably conclude that, despite their factual dissimilarity, they are roughly comparable to Case 495 in terms of overall culpability.⁷⁷

Case 553

The defendant sodomized and strangled two 7-year-old boys, killing both.

Case 362

Characterized as having a mental disorder, the defendant forced entry and robbed his victim's home. He terrorized the family and shot the victim, who died the following day. Pre-meditation may or may not have been involved.

Case 577

The mentally unbalanced defendant killed a stranger who reminded him of his stepmother.

Case 420

The young defendant, characterized as a sexual deviant, raped and murdered his victim without premeditation.

Case 494

The defendant, a disgruntled bank customer, beat, shot, and killed a bank vice-president in his home. Later, the defendant sought to extort money from the bank with a hostage claim.

Case 578

The mentally retarded defendant killed his ex-wife after beating her and carving initials in her body.

Case 581

Seeking revenge, the sexually frustrated defendant threw his girlfriend's 2-year-old child off a bridge.

Case 627

The defendant and his coperpetrator robbed, bound, gagged, beat, and shot the victim five times before burying him alive to prevent their identification. Defense claimed insanity and the use of drugs; neither was substantiated by experts. Prosecution claimed the defendant confessed.

Case 628

Defendant was a 20-year-old equipment operator, with two coperpetrators. Victim was a male insurance salesman. Defendant and coperpetrator #1 killed victim when he came to collect insurance premiums. Victim was robbed, taken to wooded area, tied to a tree, and forced to watch while defendant and coperpetrator #1 dug a shallow grave. Victim was pleading for his life. Victim was put into grave and shot five times (once in head). None of these shots killed victim, so coperpetrator #1 hit victim with a shovel. Victim was buried while still trying to speak.

Case 307

Defendant, 18-year-old male, forced victim (a stranger picked at random at shopping center) to a wooded area and shot her three times in the head with a .45 caliber revolver.

See *infra* Appendix A of this Article for a similar listing of review and appendix cases from 13 additional death sentence cases affirmed by the Georgia Supreme Court.

⁷⁶ Cases 074, 576, 551, 571, 553, 628, *supra* note 75.

⁷⁷ Cases 362, 577, 420, 494, 578, 581, 627, *supra* note 75. Another example of a judge intuitively applying an overall culpability approach is *State v. Mercer*, 618 S.W.2d at 20-22 (Seiler, J., dissenting).

III. ISSUES AND METHODOLOGY

A. THE ISSUES

Our objective was to evaluate the effectiveness of the Georgia Supreme Court's system of comparative sentence review. We sought to determine the extent to which the actual operation of Georgia's sentence review process has ensured that no person "sentenced to die by the action of an aberrant jury" would actually "suffer a sentence of death," as the United States Supreme Court assumed in the *Gregg* decision.⁷⁸

We first examined jury death-sentencing patterns from 1973 to 1978 for evidence of arbitrariness and comparative excessiveness. We then assessed the impact of the Georgia court's decisions on those patterns. Finally, we considered why the Georgia court's performance may have fallen short of the expectations of the United States Supreme Court expressed in *Gregg v. Georgia*.

The foundation of our evaluation is an assessment of the degree of comparative excessiveness in Georgia's death-sentencing system. Since an inconsistent or comparatively excessive death sentence is not self-evident, the validity of the methodology we used to identify potentially excessive sentences is central to the credibility of our conclusions. In the next section we describe that methodology in detail.

B. METHODOLOGY

We note at the outset that an exact replication of the Georgia Supreme Court's comparative sentence review procedures is impossible. One reason is that the opinions of the Georgia court do not include sufficient detail to reveal the precise methodology employed. Moreover, there is some evidence that the methodology employed may vary from case to case, depending upon the predilections of the author justice. More importantly, however, there is no universally accepted method for identifying cases that are "similar" to a given death case.

Nevertheless, we believe that the methods we have developed for these purposes are quite reliable. Each applies or builds upon an approach already in use by one or more courts.⁷⁹ Also, our methodology employs a computer-based data management system that is more comprehensive and systematic than any in current judicial use. Although we know of no other more relevant or reliable measures of comparative excessiveness than those which we employ in this analysis, we fully expect that improved methods of comparative sentence review will emerge as courts develop more experience with the process. Even with the meth-

⁷⁸ *Gregg v. Georgia*, 428 U.S. at 206.

⁷⁹ See *infra* note 85 and accompanying text.

ods we apply here, a final judgment about the comparability of the cases identified as similar by them or by the Georgia Supreme Court must await a case-by-case comparison of the records or narrative summaries of those cases. For all these reasons, we consider our results only *prima facie* evidence of the hypotheses we test.

1. *The Data*

The analysis employed two data sets. The first consisted of 130 pre-*Furman* murder defendants tried and sentenced by a jury between January 1, 1970 and September 29, 1972, the date of *Furman v. Georgia*.⁸⁰ Twenty of these defendants received a death sentence. The second data set consists of 594 defendants tried and sentenced for murder under Georgia's post-*Furman* death-sentencing statute.⁸¹ In 190 of these cases there was a penalty trial, and in twelve additional cases two or more penalty trials occurred. The result was 203 penalty trials with 113 death sentences imposed upon 100 different defendants.

2. *Measuring Comparative Excessiveness*

We use seven measures of comparative excessiveness in this study. Three are designed to assess the excessiveness of an individual death sentence and are modeled after the methods currently used by state

⁸⁰ This data set included all such cases in the files of the Georgia Department of Offender Rehabilitation as of January 1979 for which a file was available in Georgia's Department of Pardons and Paroles.

⁸¹ These cases include all offenders who were arrested and charged with murder in the state of Georgia between March 28, 1973 and June 30, 1978 and who later received a life or death sentence after trial or were sentenced to death after pleading guilty to murder. These 594 defendants represent all such offenders (a) who appealed their convictions to the Georgia Supreme Court, or (b) whose names appeared in the files of the Georgia Department of Offender Rehabilitation as of January 1979 and whose cases were available in the files of Georgia's Department of Pardons and Paroles.

Neither the pre- nor post-*Furman* samples include cases in which a sentence was imposed between the date of *Furman v. Georgia* and the date of the enactment of the revised death-sentencing statute March 28, 1973. We excluded such "transition" cases from the sample because post-*Furman* juries could not lawfully impose death sentences. Transition cases show that some death sentences were imposed by juries during this time, *Furman v. Georgia* notwithstanding. The difficulty is that when life sentences were imposed in transition cases we were unable to determine whether the jury imposed the sentence or the court had given a life sentence because of *Furman v. Georgia*.

For each case we developed a separate file, including information on over 200 potentially aggravating or mitigating factors. We obtained data on these factors from official records in the Georgia Supreme Court, the Georgia Department of Offender Rehabilitation, the Georgia Department of Pardons and Paroles, and the Georgia Bureau of Vital Statistics; when necessary we also sent questionnaires to defense counsel and prosecutors.

A copy of the questionnaire used to collect these data, as well as the codebook for over 200 "recode" variables created from the original questionnaire variables, are on file with the JOURNAL OF CRIMINAL LAW AND CRIMINOLOGY.

supreme courts. The four other measures are designed to measure system-wide excessiveness from different perspectives.

a. Case specific measures of comparative excessiveness

Georgia's proportionality review statute requires the Georgia court to determine whether each death sentence it affirms is excessive or disproportionate when compared to the sentence "imposed in similar cases, considering both the crime and the defendant."⁸² The statute gives no further guidance, however, on the method to be used in identifying similar cases. Nor do the courts or the literature reveal a uniformly accepted approach.⁸³ Given this lack of consensus, we have adopted a "triangulation" approach: we employ three different methods for identifying "similar" cases for comparative purposes with explicit recognition of the potential biases or unreliability of each.⁸⁴ This use of several different methods serves to cross-check the results of each.

(1) *The salient factors method*

Our first measure of comparative excessiveness classifies other cases as "similar" in terms of what we call the salient factors of the death case under review. These salient factors include those features of the case that seem most likely to have affected the jury's sentencing decision. The salient factors method suggests itself as a method for identifying similar cases because it approximates the apparent intent of the Georgia legislature. In addition, it is clearly the method which the Georgia Supreme Court purports to apply in its comparative sentence reviews.⁸⁵

When employing this method, one usually begins by classifying other cases in terms of any statutory aggravating circumstances present in the death sentence case under review. Then one further refines the selection process by using other factors which seem to be particularly relevant to the death-sentencing decision in the review case.⁸⁶ One then

⁸² GA. CODE ANN. § 27-2537(c)(3) (1983)

⁸³ See *supra* note 64.

⁸⁴ See Baldus, Pulaski, Woodworth & Kyle, *supra* note 1, at 16-64, for a discussion of the strength and weaknesses of the three methods used here for identifying similar cases; see also Mosteller, *Assessing Unknown Numbers: Order of Magnitude Estimation* in STATISTICS AND PUBLIC POLICY 163, 175 (W. Fairley & F. Mosteller eds. 1977), for a discussion of the triangulation concept.

⁸⁵ York Deposition 1979, *supra* note 61, at 18-20; York Deposition 1978, *supra* note 49, at 50-54. Similar methods are commonly used to evaluate claims of purposeful discrimination against individuals in employment discrimination cases, where the comparisons are called "comparative" statistics.

⁸⁶ *Godfrey v. Georgia*, 446 U.S. at 433, suggests that when differentiating between death eligible cases, the reviewing court should limit itself to case characteristics that are "rational" in terms of the goals of capital punishment, or some more specific objective suggested by the statutory aggravating circumstance involved in the case. *Godfrey* itself said that the presence

searches for other cases that resemble the case under review in terms of the identified salient factors. Cases that match the review case with respect to a sufficient number of factors constitute the pool of "similar" cases for comparative purposes.

As noted earlier, however, even in states with a large number of murder convictions, one rarely finds more than a very few cases that closely match the review case in terms of such important salient features as the statutory aggravating factor involved, the defendant's prior record and role in the crime, the number of victims, and other important factors. Consequently, when using the salient factors method, it is frequently necessary to relax the selection criteria in order to obtain a sufficiently large pool of similar cases to estimate with confidence the treatment of similar defendants. As a result, this pool expands to include cases which do not resemble the review case in all particulars, but which are similar in terms of overall culpability. Thus, one may treat as similar cases involving either a kidnapping or an armed robbery, or cases in

of a bloody, gruesome scene would not be a rational basis for distinguishing cases under a statutory provision that made "depraved" murderers death-eligible. *Id.*

Another issue that arises at this point is whether the classifying of factors used to distinguish the cases should be limited to those that are known to have influenced or caused the jury to impose a death sentence. State courts have expressed concern over their ability to identify causal factors beyond the aggravating factors on which the death sentence is based. *See, e.g., State v. Copeland*, — S.C. —, —, 300 S.E.2d 63, 77 (1982). Indeed, the determinative reasons for a death sentence are probably unknowable even to the jurors who made the decision.

The United States Supreme Court, however, does not appear to contemplate proof of the causal factors in a case beyond the death-justifying statutory aggravating circumstances. The concern of the Court is that the death-sentencing decision "be and *appear to be*, based on reason rather than caprice or emotion." *Godfrey v. Georgia*, 446 U.S. at 433 (emphasis added) (quoting *Gardner v. Florida*, 430 U.S. 349, 358 (1977)). This language implies that a court will never know all of the reasons why a death sentence was imposed. It suggests only that to the extent they are known, the actual causal factors must be based on reason and that the same test applies to the factors that appear to have influenced the decision. The implication is clear that the reviewing court should make a determination of the factors that appear to have been the basis for the death sentence decision under review and then assess their rationality.

Another issue confronting a court at this point in the analysis is whether the characteristics of the case selected for matching should be the specific facts of the case or its overall level of culpability or heinousness. Neither the United States Supreme Court nor the state statutes have provided guidance on this issue. State courts focus almost exclusively upon factual comparisons, although those cases implicitly recognize that factual comparability produces groups of cases with comparable levels of culpability. The United States Supreme Court's language, in contrast, suggests that comparisons in terms of culpability and death-worthiness are its principal concern. The Court has not, however, suggested any way of directly measuring overall case culpability. The two approaches of factual comparison and overall culpability, however, do not appear to be mutually exclusive since factual comparisons ultimately go to the issue of overall case culpability, and estimates of overall culpability intuitively or statistically based are usually tested in terms of factual comparability.

which the defendant either actively resisted arrest or committed another crime after the homicide.

We applied the salient factors method to sixty-eight post-*Furman* death sentence cases from Georgia in a manner designed to replicate the actual comparative sentence reviews of each case by the Georgia Supreme Court. We selected the salient factors for each of these sixty-eight cases after reading the Georgia Supreme Court's opinion in the case, an extensive narrative summary, and a coded questionnaire of the case.⁸⁷ We then employed a computer to search both the pre- and post-*Furman* case files for cases with comparable factors. We excluded from consideration, however, cases decided after the date of the Georgia court's decision in the case under review. And, as does the Georgia court, we limited our search to appealed cases.⁸⁸ Finally, we aimed in each of our analyses for a pool of fifteen "similar" cases, the average number of cases listed in the Georgia court's appendices of similar cases.

⁸⁷ The 68 cases selected for analysis were 68 of the first 69 death sentence cases affirmed by the Georgia court under the post-*Furman* statute.

GA. CODE ANN. § 27-2537(f) authorizes the Georgia court to examine pre-*Furman* cases in its comparative sentence reviews.

⁸⁸ Approximately one-third of murder convictions at trial were not appealed. Of those that were appealed, our sample has good coverage. A comparison of our pre-*Furman* sample of cases with all murder appeals to the Georgia Supreme Court in which sentence was imposed between January 1, 1970 and June 29, 1973 indicates that our sample includes 80% of the pre-*Furman* murder appeals. This 20% shortfall is explained (a) by cases in which an appeal was taken but the offender was not committed to the Georgia Department of Corrections because his original sentence was reversed and he was not subsequently convicted of murder, and (b) by cases in which the offender was committed to state prison but the name was inadvertently omitted from the file from which our sample was drawn. Recordkeeping personnel at the Georgia Department of Offender Rehabilitation believe that very few cases fall into this latter category.

Our sample also does not include appealed cases in which the jury's sentence was imposed between September 29, 1972 (the date of *Furman v. Georgia*) and March 28, 1973 (the date of the revised Georgia statute), since juries could not lawfully impose death sentences during this period. The sample includes, however, unappealed cases in which sentence was imposed between January 1, 1970 and the date of the *Furman* decision.

The sample of post-*Furman* cases is more exhaustive. The 68 post-*Furman* death sentence cases that are the subject of our comparative sentence review analysis, *see supra* notes 43-60 and accompanying text, were decided by the Georgia Supreme Court between March 28, 1973 and December 4, 1979. It includes 95% of the murder cases in which the crime occurred after March 28, 1973, and there was an appeal to the Georgia Supreme Court which was decided before December 4, 1979. The court decided 47 (69%) of the analyzed cases before July 1, 1978 and for the period March 28, 1973 through June 30, 1978, the sample includes all murder appeals the court decided during this period in cases where the crime occurred after March 28, 1973. Twenty-one (31%) of the reanalyzed cases were decided between July 1, 1978 and December 4, 1979. For the cases decided during this time period, our sample includes from 99% of the universe of potentially similar post-*Furman* cases, for the earliest of these cases, to 95% of the universe, for the latest case.

The Georgia Supreme Court has limited application of the 1973 death sentencing statute to cases in which both the crime and the sentence were imposed after the effective date of the new Act. *Akins v. State*, 231 Ga. 411, 412, 202 S.E.2d 62, 63 (1973).

For each group of similar cases thus selected we calculated the death-sentencing frequency.

(2) *The main determinants method*

The main determinants method defines similarity in terms of those factual characteristics which, in general, appear to influence the sentencing decisions most significantly. One identifies these "main determinants" with a multiple regression analysis. The main determinants method differs from the salient factors method in two ways. First, when choosing the similar case selection criteria under the main determinants method, one substitutes a statistical procedure for the subjective, intuitive judgment used to select salient factors. Second, because several of the main determinant factors are defined more broadly than the salient factors, the resulting groups of similar cases may be more factually diverse than those produced by the salient factors method.

In order to evaluate the Georgia Supreme Court's comparative sentence review of the sixty-eight death sentence cases using the main determinants method, we first conducted a multiple regression analysis of the capital sentencing decisions by Georgia juries in post-*Furman* cases.⁸⁹ This procedure identified the following case characteristics as those that

⁸⁹ The ordinary least squares regression results that guided the selection of the factors used to subdivide the cases were:

Case Characteristics	Partial Regression Coefficient	Standardized Partial Regression Coefficient (Beta Weight)	Relative Importance of the Variables According to the Beta Weights From 1 (most) to 20 (least)
I. Defendant			
A. Prior Record			
1. Number of prior felony convictions reported (PRIFEL)	.02	.09	12.5
2. Number of prior convictions for violent personal crimes beyond murder, armed robbery, rape/kidnap (W15D)	.07	.09	12.5
B. Motive			
1. Insurance Motive (INSMOT)	.29	.11	9
2. Racial hatred motive (RACE)	.23	.06	18
C. Role in the Crime			
1. Two or more victims killed by defendant or co-perpetrator (TWOVIC)	.20	.13	6

most significantly influenced which post-*Furman* defendants were sentenced to death:

- (1) How many people the defendant personally killed (none, one, or two or more people);
- (2) Whether the case involved a serious contemporaneous offense, *i.e.*, rape, kidnapping, or armed robbery;

Case Characteristics	Partial Regression Coefficient	Standardized Partial Regression Coefficient (Beta Weight)	Relative Importance of the Variables According to the Beta Weights
2. Defendant was not the triggerman (NOKILL)	-.13	-.12	8
II. <u>The Victim</u>			
A. Personal Characteristics			
1. Victim was police or fire (VICPFIR)	.15	.07	15.5
2. Victim was a female (FEMVIC)	.09	.10	10.5
B. Relationship to Defendant			
1. Victim was a stranger (VICSTRAN)	.09	.10	10.5
III. <u>Contemporaneous Offenses</u>			
1. Victim was kidnapped (KIDNAP)	.21	.16	2.5
2. Rape involved (RAPE)	.24	.14	4
3. Armed robbery involved (ARMROB)	.13	.16	2.5
IV. <u>Method of Killing</u>			
1. Multiple shots to head (MULSH)	.17	.13	6
2. Multiple stabs (MULSTAB)	.19	.13	6
3. Victim drowned (DROWN)	.14	.06	18
V. <u>Special Aggravating Factors</u>			
1. Number of major aggravating circumstances in the case (MAJAGCRX)	.09	.23	1
2. Victim a hostage (HOST)	.27	.08	14
3. Defendant created great risk in a public place (RPUBPLC)	.06	.06	18
4. Defendant actively resisted arrest (DEFRSARR)	.06	.05	20
VI. <u>Special Mitigating Factors</u>			
1. One or more mitigating circumstances (MITCIR)	-.06	-.07	15.5
<hr/>			
R ²	.54		

All variables were statistically significant beyond the .05 level.

- (3) Whether the case involved one or more of several major aggravating factors;⁹⁰
- (4) Whether the defendant had a felony conviction for, or a record of, violent personal crimes;
- (5) Whether the case involved one or more of several mitigating factors;⁹¹ and
- (6) Whether the case involved one or more of several minor aggravating factors.⁹²

On the basis of these main determinants, we divided the post-*Furman* sentencing decisions into successively smaller groups of cases that matched on from one to six of these mitigating and aggravating factors. We then calculated death sentencing frequencies within each subgroup. Figure 1 and Appendix B illustrate the results of this procedure.⁹³

More specifically, Figure 1 presents an overview of the results controlling for (a) the number of victims whom the defendant killed, and (b) whether there was a serious contemporaneous offense involved in the case. Each cell in the figure represents a subgroup of similar cases and indicates the death-sentencing rate for the cases in the subgroup. The fraction in parentheses beneath the death-sentencing rate indicates (a) the number of cases in the subgroup sentenced to death (the numerator), and (b) the number of cases in the cell (the denominator). For example, the top cell in Figure 1, which includes all 607 sentencing decisions in the post-*Furman* data set, indicates that the death-sentencing rate for these cases is .19 (113/607).⁹⁴ Figure 1 illustrates how the death-sentencing rate changes when one introduces controls to account for

⁹⁰ The major aggravating factors were: Torture, excessive and unnecessary pain, victim bound and/or gagged, execution-style killing, sexual perversion other than rape, victim pled for life, defendant showed pleasure with killing, mutilation, slashed throat, defendant an escapee, victim was police or fire person, multiple shots to head or multiple stab wounds, insurance motive, or victim was held hostage. The number of these factors present in a case was the most important variable in the overall regression model (MAJAGCRX), and each factor alone showed a strong unadjusted association with death-sentencing outcomes. *See also infra* note 98.

⁹¹ The mitigating factors were: Defendant showed remorse, gave self up within 24 hours, was drunk or had a history of drug or alcohol abuse, had no intent to kill, believed he or she had a moral justification, the victim was a fugitive, provoked or aroused defendant, was drinking, or using drugs or had bad blood with defendant.

⁹² The minor aggravating factors were: A race-related motive, victim was drowned, defendant resisted arrest, defendant created a great risk in a public place, or the victim was a hostage or female.

⁹³ For a similar analysis of pre-*Furman* data from California, see Baldus, Pulaski, Woodworth & Kyle, *supra* note 1, at 54-57.

⁹⁴ Although there were only 594 cases in the post-*Furman* data set, 12 of those cases involved one or more death sentences. When the total number of penalty trials related to these cases are included in the analysis and the unit of observation is the sentencing decision, the sample size is 607, with 113 death sentences imposed.

FIGURE 1

DEATH SENTENCING RATES, CONTROLLING FOR (A) THE NUMBER OF PEOPLE KILLED BY DEFENDANT, AND (B) WHETHER THERE WAS A SERIOUS CONTEMPORANEOUS OFFENSE: POST-FURMAN

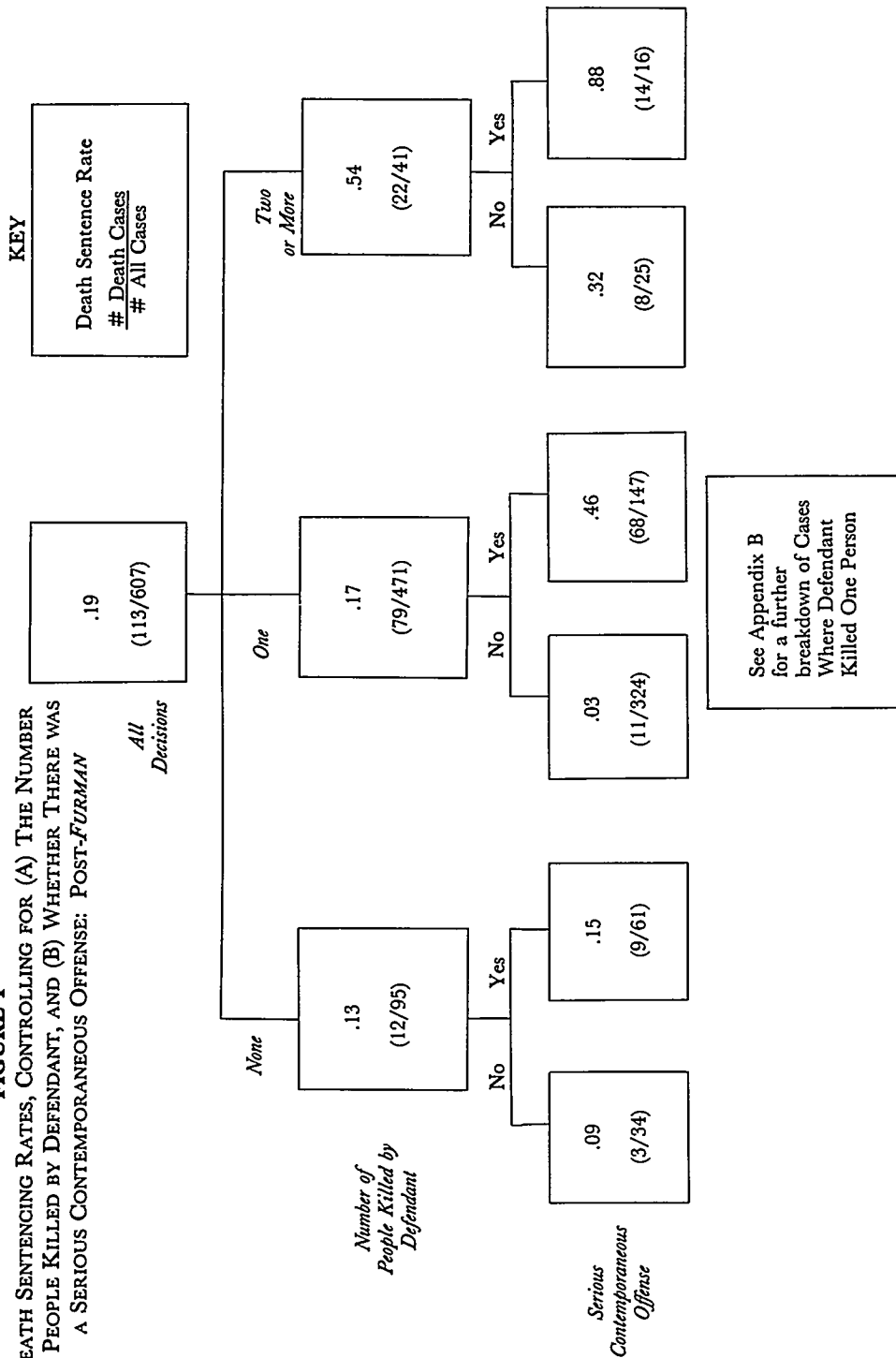

(a) the number of victims whom the defendant personally killed, and (b) whether there was a serious contemporaneous offense involved. Specifically, the second row of cells represents three groups of cases in which (a) the defendant was not the triggerman, (b) the defendant killed one person, and (c) the defendant killed two or more people. The death-sentencing rates within these subgroups of cases are .13, .17, and .54, respectively. The third row of cells further subdivides these cases on the basis of whether there was a serious contemporaneous offense involved in the case.⁹⁵

Figure 1 also reveals a substantial range of death sentencing rates among the subgroups of cases, from .03 to .88, and an observable relationship between these rates and the level of aggravation within each subgroup. For example, as one reads across the third row of cells in Figure 1, the death-sentencing rates rise, sometimes dramatically, as one moves from less to more aggravated cells. Thus, it appears that Georgia juries and prosecutors clearly responded to the aggravating and mitigating factors identified as main determinants.

To analyze the sixty-eight death sentence cases in the study, we located each review case in its respective cell in extensions to Figure 1 and calculated the death-sentencing frequency for that subgroup of cases, after eliminating non-appealed cases and those decided by the Georgia court after the date of the case under review.⁹⁶ Whenever feasible, we made this calculation for the data in the cells of the extensions to Figure 1 which control simultaneously for the six main determinants specified for the analysis. However, when there were fewer than five cases in one of these cells, we would control for fewer factors in order to obtain a sample size with at least five similar cases.

For the purposes of this study, we consider the main determinants method to be a good complement to the salient factors method because it uses similar case selection criteria that are objective and verifiable. We do not propose, however, that an appellate court should uncritically

⁹⁵ As one examines Figure 1, notice that the subgroups of cases become less aggravated as one reads to the left or down to the left, and more aggravated as one reads to the right or down to the right. We further subdivided the cases with an extension of Figure 1 which permitted the simultaneous control for six aggravating and mitigating factors. Appendix B shows the results for cases involving a single victim. A plain dash "-" within a cell in the figure indicates there were no cases with that combination of characteristics. Also note that one can obtain the best insight into the system from subgroups of cases with reasonable sample size, *i.e.*, with at least five cases. Two additional figures, similar to Appendix B, were created as extensions (a) for cases in which the defendant was not the triggerman, and (b) for cases in which the defendant killed two or more people.

⁹⁶ As noted above, the extension for defendants who killed one victim is shown in Appendix B. The extensions for the cases in which the defendant was not the triggerman or killed two or more people are not shown in this Article.

employ regression-based selection criteria for identifying similar cases.⁹⁷ Regression analysis is subject to a variety of weaknesses, one being that it can only estimate for any given factual characteristic the average impact in all cases. It cannot identify the specific factors that most influenced the jury in any particular death sentence case under review. On the other hand, we do suggest that understanding the factors that are generally important to juries may assist a court in trying to identify the most important factors in any individual case.

(3) *The index method*

The index method classifies cases as "similar" in terms of a single criterion—the probability in each case that the defendant will receive a death sentence. Similar cases are those for which the predicted likelihood of receiving a death sentence is closest to that for the death case under review. We calculated the predicted likelihood that the defendant would receive a death sentence for each case by using a multiple regression analysis of the type previously described.⁹⁸ This procedure not only

⁹⁷ A State Supreme Court can also identify the factors used to measure overall case culpability on the basis of its experience and judgment. On the dangers of excessive reliance on statistical evidence in the conduct of comparative sentence review, see *State v. Williams*, 308 N.C. 47, —, 301 S.E.2d 335, 355 (1983). The courts' experience in analyzing statistical evidence offered to prove discrimination suggests that they are quite capable of evaluating statistics on the basis of qualitative evidence and their experience and judgment. See Finklestein, *The Judicial Reception of Multiple Regression Studies in Race and Sex Discrimination Cases*, 80 COLUM. L. REV. 736 (1980).

⁹⁸ The predictions for each case were based on the combined results of three separate regression analyses. The first analysis used the 1970-1972 pre-*Furman* cases and all of the post-*Furman* cases that advanced to a penalty trial, to give full coverage to jury decisionmaking. The second analysis used all the 1970-1972 pre-*Furman* data and the post-*Furman* data for 1973-1974, which made the pre- and post-*Furman* sample sizes about equal. The third analysis used the 1970-1972 pre-*Furman* data, and the 1973-1975 post-*Furman* data, which ensured coverage for equal time periods pre- and post-*Furman*. We used pre- and post-*Furman* data because the Georgia court considers data from both periods in its comparative sentence reviews. We used the results from three different regression analyses because of the tendency of each analysis to produce a unique solution which omitted obviously important and relevant variables. For example, the following variables were omitted from one or more of the models: Number of Prior Felony Convictions (PRIFEL); Victim a Hostage (HOST); Number of Convictions for Murder, Armed Robbery, Rape, Aggravated Battery, Burglary, Arson (VPCX); Defendant Not the Triggerman (NOKILL); Defendant Created Risk of Death in a Public Place (PBQB3); and Insurance Motive (INSMOT).

The regression analyses used to produce the predicted likelihood of a death sentence also included variables for the race of the victim and the race of the defendant. This was done to increase the validity of the weight assigned to each legitimate aggravating and mitigating factor underlying the index. These racial factors, however, were not included in the formula used to give each case its final predicted likelihood of a death sentence. Only legitimate factors were used for that purpose. See *Zant v. Stephens*, 103 S. Ct. at 2739-41. Also excluded from the index were variables that did not attain statistical significance at the .10 level and a handful of legitimate variables for which the regression analysis estimated a regression coefficient with the wrong sign, *i.e.*, the sign of the coefficient was not in the expected direction. An

identified the factual characteristics that best explained the capital sentencing decisions in the cases we studied, but also weighed the relative

example would be a positive sign for a mitigating factor, which in a rational system would have a negative effect on a defendant's chances of receiving a death sentence. The rationale for excluding these apparently irrational variables is the teaching of *Godfrey v. Georgia*, 446 U.S. at 433 n.16, that similar cases should be identified in terms of case characteristics that are rationally related to the purposes of the death sentencing statute. We selected the variables used in the index from a list of over 200 variables in a screening procedure that commenced with a factor analysis and concluded with an ordinary least squares backward elimination multiple regression analysis. The results are shown in the table below. The score for each case was produced with the weights in Column E which are the means of the estimated coefficients in Columns B, C and D.

Variables	Partial Regression Coefficients ^a			Weights for Index (EXCSIDX3)	
	<u>A</u>	<u>B</u>	<u>C</u>	<u>D</u>	<u>E</u>
1. Defendant created risk of death in a public place (PBQ B3)		.10	.0	.0	.03
2. Defendant was minor participant in the murder (STMIT6)		-.27	.0	.0	-.09
3. Dispute due to influence of drugs or alcohol (DRUGDIS)		-.13	-.08	.0	-.07
4. Defendant status sympathetic (MITDEFN)		.0	.0	-.16	-.05
5. One or more white victims (WHIVICRC)		.0	.11	.09	-
6. Black Defendant (BLACKD)		.0	.13	.09	-
7. Number of prior convictions for other violent personal crimes beyond murder, armed robbery, rape and kidnapping (W15D)		.12	.0	.0	.04
8. Insurance motive (INSMOT)		.26	.0	.24	.17
9. Victim was kidnapped (KIDNAP)		.19	.19	.0	.10
10. Rape involved (RAPE)		.24	.0	.08	.11
11. Multiple shots (MULSH)		.32	.27	.30	.30
12. Victim drowned (DROWN)		.0	.0	.37	.12
13. Number of Major aggravating circumstances (MAJAGCRX)		.15	.11	.10	.12
14. Race hatred motive (RACE)		.0	.30	.23	.18
15. Number of prior felony convictions reported (PRIFEL)		.0	.0	.02	.01
16. Victim was a stranger (VICSTRAN)		.0	.18	.17	.12
17. Motive to facilitate nonproperty related crime (NONPCRN)		.0	.0	.21	.07
18. Victim was a hostage (HOST)		.0	.41	.0	.14
19. Number of convictions for murder, armed robbery, rape, aggravated battery, burglary, arson (VPCX)		.0	.11	.11	.07
20. Defendant engaged in nonviolent crime (NONVCOF)		.0	.18	.0	.06
21. Defendant not the triggerman (NOKILL)		.0	-.13	-.10	-.08
22. Number of Georgia statutory death eligibility factors in case (PEQDELX)		.07	.0	.0	.02
23. Multiple stabs (MULSTAB)		.15	.0	.0	.05

importance of each characteristic. With this information, we computed a score for each case which reflected the relative likelihood that a defendant would receive a death sentence. We then ranked the cases ac-

24. Two or more victims killed by defendant and/or co-perpetrator (TWOVICAL)	.0	.22	.22	.15
25. Defendant committed additional crime after killing (ADCRIM)	.0	.23	.19	.14
26. Victim low status (VICLSTAT)	.0	.0	-.08	-.03
	R ²	.47	.49	.52

a Coefficients are listed if they were statistically significant beyond the .10 level in a stepwise regression. A "0" means the variable did not enter the analysis at the .10 level of statistical significance or beyond.

After each case was assigned an index score, the following scale (AFURSCL2) was created:

- If EXCSIDX3 LT -.05 then AFURSCL2 = 1
- If -.05 LE EXCSIDX3 LT .09 then AFURSCL2 = 2
- If .09 LE EXCSIDX3 LT .23 then AFURSCL2 = 3
- If .23 LE EXCSIDX3 LT .37 then AFURSCL2 = 4
- If .37 LE EXCSIDX3 LT .51 then AFURSCL2 = 5
- If .51 LE EXCSIDX3 LT .65 then AFURSCL2 = 6
- If .65 LE EXCSIDX3 LT .79 then AFURSCL2 = 7
- If EXCSIDX3 GE .79 then AFURSCL2 = 8

We also used logistic regression techniques to construct an alternative index and scale for evaluating comparative excessiveness. The procedure commenced with approximately 80 legitimate variables that were used in the final screen used to construct the index just described. The same three pools of pre- and post-*Furman* data were used to create the regression models as were employed in the ordinary least squares analyses, and the coefficients were combined in the same fashion to create the final logistic-based index with the variables that entered one or more of the analyses at the .10 level of statistical significance. The correlation between the final logistic-based index and the index created with the ordinary least squares (O.L.S.) procedure was .85, and the O.L.S. index correlated somewhat better with death-sentencing outcomes ($r = .62$ for the O.L.S. index v. $r = .56$ for the logistic based index).

The following table indicates that the death sentencing frequencies among the different groups of cases were substantially the same.

Death Sentencing Rates Among Groups of Similar Cases Identified with Indices and Scales Developed with:

A) ORDINARY LEAST SQUARES (O.L.S.), and
 B) LOGISTIC REGRESSION PROCEDURES

<u>A</u>	<u>B</u>	<u>C</u>
Predicted Likelihood of a Death Sentence Low (1) to High (8)	Evidence from O.L.S. Index and Scale	Evidence from Index and Scale Developed With Logistic Regression Procedures
1	.0 (0/36)	.0 (0/3)
2	.0 (0/207)	.02 (1/61)
3	.07 (9/136)	.02 (4/165)
4	.17 (15/90)	.06 (10/166)
5	.36 (19/53)	.26 (24/92)
6	.75 (27/36)	.64 (30/47)
7	.67 (10/15)	.70 (19/27)
8	.97 (33/34)	.96 (25/26)

ording to this index and classified as similar the thirteen cases decided prior to the date of the death sentence case that ranked immediately above the review case on the index and the thirteen cases decided prior to the date of the review case that ranked immediately below it on the index.⁹⁹ We then calculated the aggregate death-sentencing frequency for these twenty-six cases.

A strength of the index method is that it allows one to match cases simultaneously on the basis of a large number of case characteristics. The multiple regression procedure permits this result by reducing the characteristics of all of the aggravating and mitigating factors identified as important in the regression analysis to a single dimension, the index score. A drawback of the procedure, however, is the factual differences that may exist between cases ranked as similar in terms of their respective index scores.¹⁰⁰

Although no court has used this index method for identifying similar cases in any formal sense, some Georgia Supreme Court justices appear to use an intuitive method that is quite comparable. As noted earlier, an analysis of the court's appendices suggests that some justices compare defendants in capital cases on the basis of their relative culpability or blameworthiness without regard to the absence of factual similarities.¹⁰¹ The court's opinions also suggest that some justices attempt to assess intuitively the significance of specific factual characteristics in other cases based upon the decisions of the sentencing juries. For both of these reasons, we suggest that the manner in which these justices assess the relative culpability of a particular defendant by analyzing the sentences imposed in other cases roughly approximates the more formal procedures of this index method.

b. Systemwide measures of comparative excessiveness

Some insight into systemwide excessiveness is provided by aggregating the results of the analyses we conducted for sixty-eight death sentence cases. We also considered it useful to present an overview of the

⁹⁹ When there was more than one case with the same index score as the highest or lowest of the 26 bracketing the subject case, all the cases with the highest or lowest score were included in the group of near neighbors. This frequently resulted in more than 26 similar cases.

¹⁰⁰ See *supra* note 84.

¹⁰¹ See *supra* note 74 and accompanying text for further evidence on the court's use of an overall culpability method of identifying similar cases.

Multiple regression procedures are commonly used in employment discrimination cases to determine the extent to which similarly situated people are treated alike. See Finkelstein, *supra* note 97; Fisher, *Multiple Regression in Legal Proceedings*, 80 COLUM. L. REV. 702 (1980). Although the ultimate issue in a discrimination case (the differential treatment of protected and unprotected groups and the reasons for the distinctions) is different from the ultimate issue in comparative proportionality review, the methodological issues involved in defining groups of similar people are comparable.

system that embraced all life and death sentence cases without regard to the date of decision or the presence or absence of an appeal. For the purposes of conducting this evaluation, we employed four different methods of identifying similar cases, three based on legislatively prescribed criteria and two based on the factual characteristics which best explain the actual death-sentencing decisions in a multiple regression analysis.

(1) *Legislative criteria measures*

Two of the similar case selection criteria we employed are based on factors identified as relevant to the sentencing decision by Georgia's post-*Furman* capital sentencing statute. These selection criteria classify as similar:

- (1) all cases in which the same statutory aggravating circumstance is present;¹⁰² and
- (2) cases in which an equal number of statutory aggravating circumstances is present.

¹⁰² Under the Georgia law, a defendant convicted of murder is eligible for a death sentence if one or more of the following factors listed in GA. CODE ANN. § 27-2534-1 (1983) is present:

B1 Defendant had a prior record of conviction for murder, rape, armed robbery, or kidnapping with bodily injury.

B2 The defendant was engaged in a contemporaneous murder, rape, armed robbery, kidnapping with bodily injury, aggravated battery, burglary, or arson in the first degree.

B3 The defendant created a great risk of death to two or more people in a public place with a dangerous weapon.

B4 The defendant's motive was to receive or obtain for himself or another money or any other thing of monetary value.

B5 The defendant killed a judicial officer or district attorney because of the exercise of his or her official duty.

B6 The murder was for hire.

B7 The murder was "outrageously or wantonly vile, horrible, or inhuman in that it involved torture, depravity of mind, or an aggravated battery to the victim."

B8 The victim was an on-duty police, corrections, or fire person.

B9 The defendant was in custody or an escapee from custody.

B10 The defendant killed to effect his or another's escape from custody or to prevent his or another's arrest.

For the purposes of this study, the B7 factor "outrageously or wantonly vile" is considered present in case when one or more of the following conditions exists:

1. Mutilation of the victim before or after death;
2. Death as a result of multiple wounds or contusions;
3. Sexual abuse or perversion, other than rape prior to death, or the victim pled for his or her life prior to death;
4. Death by severe beating, strangulation, drowning, poisoning, or multiple painful methods of killing;
5. The contemporaneous existence of rape, armed robbery, or kidnapping with bodily injury, and a motive to silence a witness, or obtain money, and a) the victim was helpless, or b) the victim was killed execution-style.

The B7 factors were identified in an analysis of over 50 cases in which the Georgia Supreme Court ruled on the scope of the B7 aggravating circumstance.

Each of these measures is straightforward and easy to understand. Their validity does not depend on statistical analyses or unverifiable assumptions. They are each limited, however, by their failure to account for a number of obviously relevant aggravating and mitigating factors.

(2) *Regression-based scales*

We developed the first regression-based scale from the predicted sentence index already described, using the cases of all defendants convicted of murder at trial during the pre- and post-*Furman* periods.¹⁰³ Employing this index, we divided our entire universe of post-*Furman* cases into eight groups, clustered according to the predicted likelihood that the defendants in each would receive a death sentence. We also developed regression-based scales employing a predicted sentence index but using only post-*Furman* data.¹⁰⁴ These scales also grouped the post-*Furman* cases according to the likelihood that each defendant convicted

¹⁰³ For a description of the index underlying this scale, see *supra* note 98.

¹⁰⁴ The results of the regression analysis which used both ordinary least squares (O.L.S.) and logistic procedures to create the indices and scales were as follows:

Variables	Ordinary Least Squares Regression Coefficients	Logistic Regression Coefficients
1. Defendant created risk of death in a public place. (PBQB3)	.07	1.21
2. Victim 12 years old or less. (YNQVIC)	---- ^a	1.27
3. Defendant was a prisoner or escapee. (PBQB9)	---- ^a	1.25
4. Number of prior felony convictions reported. (PRIFEL)	.02	1.87
5. Two or more victims killed by defendant. (TWOVIC)	.19	2.70
6. Defendant not the triggerman. (NOKILL)	-.08	---- ^a
7. Victim was police or fire person. (VICPFIR)	.18	---- ^a
8. Victim was a female. (FEMVIC)	.07	1.61
9. Victim was a stranger. (VICSTRAN)	.10	1.29
10. Victim was kidnapped. (KIDNAP)	.20	.84
11. Rape involved. (RAPE)	.21	2.21
12. Armed robbery involved. (ARMROB)	.12	1.0
13. Number of aggravating factors. (AGGCIRX)	.02	.34
14. Number of convictions for violent personal crimes beyond murder, armed robbery, rape and kidnapping. (W15D)	.07	.64
15. Victim a hostage. (HOST)	.26	2.29
16. Multiple shots. (MULSH)	.15	1.57
17. Victim was drowned. (DROWN)	.15	1.48
18. Insurance motive. (INSMOT)	.24	1.80
19. Defendant invoked insanity defense. (INSANE)	.10	1.64
17. Multiple stabs. (MULSTAB)	.15	1.38
21. Number of major aggravating circumstances. (MAJAGCRX)	.05	.56

of murder at trial would receive a death sentence. The advantage of these regression-based measures is that they define similarity in terms of all of the legitimate aggravating and mitigating factors that help explain who is sentenced to death. There are, however, dangers in relying too heavily on a single set of regression results.¹⁰⁵ The principal problem with the regression-based approaches is the circularity inherent in using factors identified as the most predictive of the observed results as the basis for testing the system's consistency. The tendency of multiple regression analyses to generate a unique overfitted solution with respect to a particular set of decisions compounds this problem.¹⁰⁶ The result is that matches based upon factors identified in this way tend to exaggerate the degree of consistency within the system undergoing analysis.

c. Evaluating excessiveness levels

We previously defined a death sentence to be comparatively excessive if other defendants with factually similar backgrounds receive the death penalty only infrequently for committing factually similar offenses.¹⁰⁷ We base this definition upon the United States Supreme Court's opinion in *Gregg v. Georgia*, which approved of Georgia's comparative sentence review procedure.¹⁰⁸ There is, however, no court opinion that provides a quantified measure of comparative excessiveness. In *Eberheart v. State*, the Georgia Supreme Court approved imposition of the death penalty in a case involving a non-fatal kidnap-rape, although only seven of the fourteen "similar" cases cited in its opinion resulted in

22. Defendant actively resisted arrest. (DEFRSARR)	---- ^a	.78
23. One or more mitigating circumstances. (MITCIR)	-.06	-.52
24. Defendant was minor participant in the murder. (STMIT6)	-.13	-3.76
25. Racial hatred motive. (RACE)	.25	2.91
26. Constant Term.	-.06	-6.85
	Adjusted R ² =	.54

^a "----" means the variable did not enter the analysis at the .10 level of statistical significance.

The regression analyses are the product of the same type of screening procedure described in note 98, *supra*. They include all legitimate variables that entered the analysis at the .10 level of statistical significance.

¹⁰⁵ See D. BALDUS & J. COLE, *STATISTICAL PROOF OF DISCRIMINATION* 273-86 (1980); Finkelstein, *supra* note 97; Fisher, *supra* note 101, for a discussion of threats to validity in regression results.

¹⁰⁶ "Overfitting" refers to the inclusion through chance correlation of extraneous non-causal variables in a regression equation. A consequence of overfitting is that the results of the regression analysis may exaggerate the apparent consistency of the system which produced the data set used to estimate the model.

¹⁰⁷ See *supra* note 1.

¹⁰⁸ See *supra* text accompanying note 42.

death sentences for similar offense.¹⁰⁹ On the other hand, in the earlier decision of *Coley v. State*, which also involved a non-fatal rape, the Georgia Supreme Court vacated the death penalty as excessive based upon the results of twelve other cases involving fourteen defendants, of whom only thirty-six percent (5/14) received death sentences.¹¹⁰ Although these two decisions are by no means conclusive, they suggest that the Georgia Supreme Court may classify a death sentence as excessive if the death-sentencing frequency in "similar" cases is somewhat less than .35.¹¹¹

This suggested approach to a quantified measure of comparative excessiveness is also consistent with Justice Stewart's plurality opinion in *Gregg v. Georgia*. When describing the Georgia Supreme Court's appellate review process in death penalty cases as an important statutory safeguard, Justice Stewart commented as follows:

The provision for appellate review in the Georgia capital-sentencing system serves as a check against the random or arbitrary imposition of the death penalty. In particular, the proportionality review substantially eliminates the possibility that a person will be sentenced to die by the action of an aberrant jury. *If a time comes when juries generally do not impose the death sentence in a certain kind of murder case*, the appellate review procedures assure that no defendant convicted under such circumstances will suffer a sentence of death.¹¹²

In other words, like the Georgia Supreme Court, Justice Stewart seems to regard comparative sentence review as a safeguard only against the type of aberrant, lightning-strike death sentences he condemned in *Furman*.¹¹³ By contrast, Justice White, in his concurring opinions in *Furman* and *Gregg*, suggested a different approach to the quantification of comparative excessiveness.

Justice White's *Furman* opinion expressed concern with the impact of erratic and infrequent death sentences upon the viability of capital punishment as a general deterrent. In Justice White's view, the death penalty could not serve as an effective—and, therefore, constitutional—deterrent unless imposed "with sufficient frequency."¹¹⁴ Similarly, when

¹⁰⁹ 232 Ga. 247, 206 S.E.2d 12 (1974).

¹¹⁰ 231 Ga. 829, 204 S.E.2d 612 (1974).

¹¹¹ Complicating this attempt at quantification is *Moore v. State*, 233 Ga. 861, 213 S.E.2d 829 (1975). In *Moore*, the Georgia Supreme Court stated, "we view it to be our duty under the similarity standard to assure that no death sentence is affirmed unless in similar cases throughout the state the death penalty has been imposed generally . . ." *Id.* at 864, 213 S.E.2d at 832. Indeed, the United States Supreme Court invoked this language to describe the Georgia procedure in *Gregg*. 428 U.S. at 205. In fact, however, juries imposed death sentences in only .39 of the cases identified by the Georgia Supreme Court in *Moore* as similar. Nevertheless, the Georgia court affirmed Moore's death sentence because "juries faced with similar factual situations have imposed death sentences." 233 Ga. at 866, 213 S.E.2d at 833.

¹¹² 428 U.S. at 206 (emphasis added).

¹¹³ *See Furman v. Georgia*, 408 U.S. at 309 (Stewart, J., concurring).

¹¹⁴ *Id.* at 312 (White, J., concurring).

concurring in *Gregg*, Justice White asserted that, if Georgia juries imposed the death penalty in "a substantial portion" of capital cases involving statutory aggravating circumstances, the sanction would demonstrate its usefulness and, therefore, its constitutionality.¹¹⁵ Implicit in this deterrence-oriented approach, however, is the notion that, if the frequency of death sentences within an identifiable class of murder cases is less than substantial, the constitutional concerns that Justice White expressed in *Furman* would remain unsatisfied. In other words, unless the death penalty is regularly imposed in identifiable classes of cases, its usefulness as a deterrent remains suspect.

This concern with regularity of imposition, which characterizes Justice White's concurring opinions, takes on added force when one also considers the Court's repeated reference to "evenhanded" sentencing in capital cases as a constitutional goal. In a variety of opinions a number of different Justices have identified the absence of evenhandedness as the central defect condemned in *Furman v. Georgia*.¹¹⁶ In this respect, Justice White's concern with regularity in the imposition of the death penalty is more consistent with the "evenhandedness" mode of analysis than Justice Stewart's apparent concern with preventing only aberrant death sentences.

The potential tension between Justice Stewart's notion of what constitutes impermissible excessiveness, and that implicit in Justice White's opinions and the "evenhandedness" approach emerges when one considers a case like *Eberheart v. State*.¹¹⁷ In *Eberheart* the frequency of death sentences among cases deemed "similar" by the Georgia Supreme Court was .50. Certainly, from Justice Stewart's perspective, under these circumstances Eberheart's own death sentence would not be aberrant. But, conceivably, Justice White might not regard a .50 death-sentencing rate as sufficiently regular to make the death penalty in that class of case a viable deterrent. And, certainly, imposing the death penalty in only one out of every two factually similar cases does not satisfy the conventional notion of evenhandedness.

As a result, one can plausibly argue that comparatively excessive death sentences can occur even if the frequency of death sentences among similar cases is substantially greater than .35. So long as that frequency is too low to comply with notions of evenhandedness or regularity—something less than .8, for example—one can contend that imposition of the death penalty in any such case is comparatively excessive.

Obviously, without resolving this potential conflict between Justice

¹¹⁵ 428 U.S. at 222.

¹¹⁶ See *supra* note 2.

¹¹⁷ 109 Ga. 247, 206 S.E.2d 12 (1974).

Stewart's "aberrant" approach and the "evenhanded" approach espoused by Justice White and other members of the Court, exact quantification of a measure of excessiveness is impossible. We have not undertaken that task. Instead, on the basis of this analysis, we have adopted the convention of classifying death sentences as presumptively comparatively excessive if the death-sentencing rate among similar cases is less than .35. If the death-sentencing rate is .80 or greater, we classify the case as presumptively evenhanded. For cases involving death-sentencing frequencies between those two benchmarks, we adopt no formal classification. Especially given the tentative nature of our various systems for identifying other cases as "similar," it seems unnecessary to attempt any more precise quantification of potentially excessive death sentences.

IV. THE RESULTS

A. THE EVIDENCE OF COMPARATIVE EXCESSIVENESS IN GEORGIA'S POST-*FURMAN* DEATH-SENTENCING SYSTEM

In this section we present data on death-sentencing frequencies under Georgia's post-*Furman* statute.

1. *Systemwide Measures*

Seventeen percent of all defendants convicted of murder at trial during the period 1973-78 received a death sentence (100/594).¹¹⁸ Of those convicted defendants who were death-eligible because of the presence of one or more of the statutory aggravating factors, the death-sentencing rate was .22 (100/463).¹¹⁹ This death-sentencing rate varied significantly among the different classes of death-eligible cases, as Table 1 indicates. Nevertheless, the rate exceeded .50 in only one small category of cases, B-9. In the two statutory categories that accounted for the major proportion of death sentences, B-2 and B-7, the death-sentencing rate is well below .50.¹²⁰ In other words, under Georgia's post-*Furman* statute during the period studied, statutorily death-eligible defendants did not regularly receive the death penalty. Rather, juries and prosecutors continued to exercise considerable discretion and selected only a relatively few defendants for the ultimate sanction.

¹¹⁸ Some of the trials which occurred in 1978 and 1979 may have been omitted because of record-keeping delays in the Georgia Department of Offender Rehabilitation.

¹¹⁹ See *supra* note 102 for a listing of the 10 statutory aggravating factors under the Georgia death sentencing statute.

¹²⁰ In 85% of the death-sentenced cases in our sample, the sentencing authority found the B2 or B7 statutory aggravating factor to exist in the case.

TABLE 1
DEATH SENTENCING RATES FOR DEATH ELIGIBLE DEFENDANTS
UNDER EACH OF GEORGIA'S STATUTORY AGGRAVATING FACTORS^a

<u>A</u> Georgia Statutory Aggravating Factors	<u>B</u> Death Sentencing Rate
1. Prior capital record (B-1)	.33 (13/40)
2. Enumerated contemporaneous offense (B-2)	.34 (86/253)
3. Risk of death to 2 or more in public (B-3)	.20 (19/94)
4. Money/value motive (B-4)	.36 (70/196)
5. Victim/judicial officer (B-5)	.—. ^b
6. Murder for hire (B-6)	.22 (4/18)
7. Murder vile, horrible or inhuman (B-7)	.29 (83/288)
8. Victim/police or fire person (B-8)	.31 (5/16)
9. Defendant prisoner or escapee (B-9)	.53 (9/17)
10. Killing to avoid/stop arrest (B-10)	.31 (37/121)

^a This measure refers to the presence of a statutory aggravating factor in a case regardless of whether it was found by the jury or whether there was even a penalty trial in the case.

^b “. — .” means no cases.

Table 2 sheds some light on the factors influencing this exercise of discretion. Table 2 suggests that the likelihood a defendant would receive a death sentence increased significantly if his case involved more than one statutory aggravating factor. Indeed, Georgia juries imposed seventy-nine percent of the death sentences present in our study against defendants whose cases involved three or more statutory aggravating factors. Nevertheless, even for these highly aggravated cases the death-sentencing rate did not exceed .62.

Table 3 depicts the results from our two regression-based scales.

Each scale subdivides the cases into eight categories according to the predicted likelihood of receiving a death sentence. Column B employs a predicted sentencing index using both pre- and post-*Furman* cases, while Column C employs only post-*Furman* data. As we noted earlier, the results in Column C probably overstate the degree of consistency of the

TABLE 2

I. DEATH SENTENCING RATES CONTROLLING FOR THE NUMBER OF GEORGIA STATUTORY AGGRAVATING FACTORS PRESENT^a

A Number of Statutory Aggravating Factors Present ^b	B Death Sentence Rate
0	.0 (0/132)
1	.03 (5/150)
2	.12 (16/136)
3	.37 (37/99)
4	.53 (33/62)
5	.62 (8/13)
6	.50 (1/2)

II. NUMBER AND PROPORTION OF DEATH SENTENCE CASES FOR WHICH THE DEATH SENTENCING FREQUENCY IN SIMILAR CASES WAS:

A. Less than .35	.21 (21/100)
B. .80 or More	.0 (0/100)

^a This measure refers to the number of statutory aggravating factors in the case regardless of whether they were found by the jury or even whether there was a penalty trial in the case.

^b The correlation coefficient between the death sentencing rate and the number of statutory aggravating factors in the case is .49.

TABLE 3

I. DEATH SENTENCING RATES CONTROLLING FOR THE PREDICTED LIKELIHOOD OF RECEIVING A DEATH SENTENCE

<u>A</u>	<u>B</u>	<u>C</u>
Predicted Likelihood of Receiving a Death Sentence from 1 (low) to 8 (high)	Prediction Based on Analysis of Pre- and Post- <i>Furman</i> Data ^a	Prediction Based on Analysis of Post- <i>Furman</i> Data ^b
1	.0 (0/36)	.0 (0/41)
2	.0 (0/207)	.0 (0/177)
3	.07 (9/136)	.01 (1/138)
4	.14 (12/87)	.15 (15/103)
5	.33 (17/51)	.24 (10/42)
6	.74 (26/35)	.56 (14/25)
7	.67 (10/15)	.74 (20/27)
8	.96 (26/27)	.98 (40/41)

II. NUMBER AND PROPORTION OF DEATH SENTENCE CASES FOR WHICH THE DEATH SENTENCE FREQUENCY IN SIMILAR CASES WAS:

A. Less than .35	.38 (38/100)	.26 (26/100)
B. .80 or More	.26 (26/100)	.40 (40/100)

^a See *supra* note 98 and accompanying text for an explanation of how this index and scale were created. The correlation between this index and the death sentencing outcome among the post-*Furman* cases is .67.

^b See *supra* note 104 and accompanying text for an explanation of how this index and scale were created. The correlation between this index and the death sentencing outcome among the post-*Furman* cases is .75.

system.¹²¹ Nevertheless, even these results suggest that twenty-six percent of the death sentences covered in our study occurred in cases with a predicted death-sentencing rate, based upon the results in similar cases, of less than .35. The results in Column B, which may be more realistic, indicate that only twenty-six percent of the defendants who actually received death sentences committed crimes for which the predicted death-sentencing rate exceeded .80.

The data reflected in Tables 2 and 3 belie any suggestion that Georgia's post-*Furman* capital sentencing statute operated in a completely random fashion. In particular, the frequency with which juries imposed the death penalty increased with the number of statutory aggravating factors. Nevertheless, the death-sentencing rates observed among cases defined as similar in terms of the statutory aggravating factors appear to be well below the rates that the United States Supreme Court contemplated in *Gregg v. Georgia*.¹²² Only among the most aggravated cases in our regression-based scales does one observe the kind of high death-sentencing rates that the Supreme Court expected would result in death-eligible cases generally.

Thus, despite enactment of Georgia's post-*Furman* statute with its legislatively identified categories of death-eligible offenses, the question of comparative excessiveness remains unresolved. When a majority of death-eligible defendants do not receive a death sentence, the evenhandedness of the process by which a relatively few defendants do receive death sentences remains in doubt. Thus, the efficacy of the Georgia Supreme Court's system of comparative sentence review—the

¹²¹ See *supra* note 106 for further discussion of this issue. The post-*Furman* scale based on a logistic regression analysis produced death sentencing figures that were comparable to those produced with the index and scale constructed from an ordinary least squares analysis. The results from the logistic based scale were as follows:

Level of Predicted Likelihood of a death sentence, from low (1) to high (8)							
1	2	3	4	5	6	7	8
Proportion of Death Sentences (life/death cases)							
0	.01	0	.12	.27	.58	.77	1.0
(0/41)	(1/177)	(0/138)	(12/103)	(11/41)	(15/26)	(24/31)	(37/37)

Overall the logistic based measure suggested that in 24% (24/100) of the death sentence cases the death-sentencing frequency among similar cases was less than .35 and in 37% (37/100) of the cases the death-sentencing frequency among similar cases was .80 or more.

Both the O.L.S. and logistic regression analysis based on the post-*Furman* data were limited to variables that demonstrated a statistically significant relationship with the outcome variable beyond the .10 level and revealed a coefficient whose sign was in expected direction. The rationale for excluding variables with a "wrong" sign is presented in note 98, *supra*.

¹²² See *Gregg v. Georgia*, 428 U.S. at 224 (White, J., concurring), for evidence of Justice White's assumption about the frequency with which death sentences would be imposed in death-eligible cases. We assume this expectation was shared by the Court generally.

key safeguard against excessive or inconsistent death sentences—becomes critical.

2. *Case Specific Measures*

Among our case specific measures of comparative excessiveness, we consider the salient factors method the most relevant because it most closely approximates how the Georgia court purports to review death sentences.¹²³ We applied this method to sixty-eight cases in which the Georgia court had earlier conducted a comparative sentence review.¹²⁴ For each case we identified a group of cases deemed similar to the death case under review in terms of an average of 3.6 salient factors and calculated the death-sentencing rate among the cases selected.¹²⁵ The average death-sentencing rate among similar cases was .46. Figure 2 shows a distribution of the death-sentencing frequencies among similar cases for the sixty-eight cases. The horizontal axis indicates the proportions of death sentences found among the various groups of similar cases, while the vertical axis indicates the number of cases from our pool of sixty-eight death sentence cases with that death-sentencing frequency among similar cases. For example, the farthest bar to the right indicates that in four of the cases reanalyzed, all of the similar cases resulted in a death sentence. The data in Figure 2 indicate that, in twenty-five percent (17/68) of the sixty-eight death sentence cases we studied, the death-sentencing rate among similar cases was less than .35; and that in only 10 percent (7/68) of the cases studied did it exceed .80.

When we selected similar cases on the basis of those factors our regression analyses identified as most important, the death-sentencing rates among similar cases increased considerably. Figure 3 shows the results of these analyses using the main determinants and index methods.¹²⁶ The results we derived using the index method reflected the

¹²³ See *supra* notes 44-73 and accompanying text for a discussion of the Georgia Supreme Court's purported method of reviewing death cases. See *supra* notes 85-88 and accompanying text for a discussion of the salient factors method generally.

¹²⁴ See *supra* note 87-88 and accompanying text for a discussion of the universe of cases in which each search was conducted.

¹²⁵ The number of salient factors matched on in the 68 reanalyses ranged from one to six and the number of similar cases identified ranged from 4 to 32. The smaller pools of similar cases were from the early cases for which the pool of potentially similar cases was quite small.

¹²⁶ For the analysis using the main determinants method, the number of matching factors ranged from one to six and the number of cases deemed similar ranged from 5 to 24. For the index measure the number of cases deemed similar ranged from 25 to 38. See *supra* note 89 and accompanying text for a discussion of the main determinants approach. See *supra* note 98 and accompanying text for a discussion of the index method.

We also conducted a case-by-case analysis with an index based only on the post-*Furman* data. The index was a forerunner of the one described *supra* note 104 and correlated with the latter index at .92. In that analysis, 13 (9/68) of the cases showed a death-sentencing frequency below .35 among similar cases and 40% (27/68) showed a rate of .80 or higher.

FIGURE 2
 DISTRIBUTION OF 68 DEATH SENTENCE CASES REANALYZED WITH
 THE SALIENT FACTORS METHOD OF IDENTIFYING SIMILAR CASES
 ACCORDING TO THE PROPORTION OF DEATH SENTENCE CASES
 AMONG CASES DEEMED SIMILAR TO THE DEATH SENTENCE CASE
 UNDER REVIEW

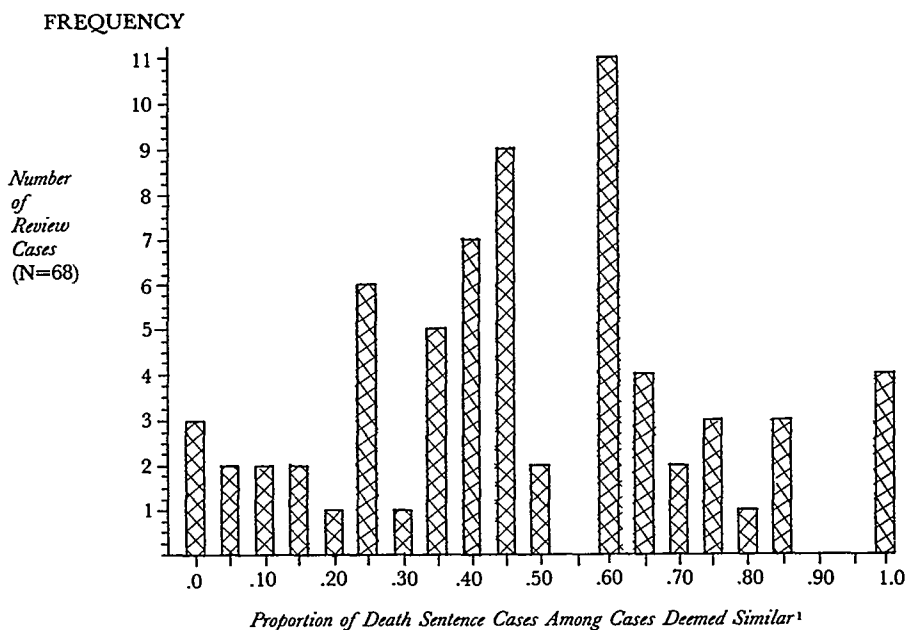

¹ Except for .0 and 1.0, points on the scale include cases with the proportion indicated plus cases immediately above the next lower point on the scale, e.g., the bar at .50 represents cases with death sentencing frequencies among similar cases ranging from more than .45 to and including .50.

greatest level of consistency or evenhandedness. The average death-sentencing frequency among all cases selected as similar by the index method was .68. Moreover, when analyzed using this method, half of the sixty-eight death sentence cases in our study (34/68) qualified as presumptively evenhanded in that the death-sentencing frequency among similar cases exceeded .80. By contrast, only thirteen percent (9/68) qualified as presumptively excessive, using our frequency benchmark of less than .35. The results we derived when using the main determinants matching method for selecting similar cases were less impressive. The average death-sentencing frequency among all cases

FIGURE 3
 DISTRIBUTIONS OF DEATH SENTENCE CASES REANALYZED WITH
 TWO METHODS OF IDENTIFYING SIMILAR CASES ACCORDING TO THE
 PROPORTION OF DEATH SENTENCE CASES AMONG CASES DEEMED
 SIMILAR TO THE DEATH SENTENCE CASE UNDER REVIEW

I. INDEX METHOD

FREQUENCY

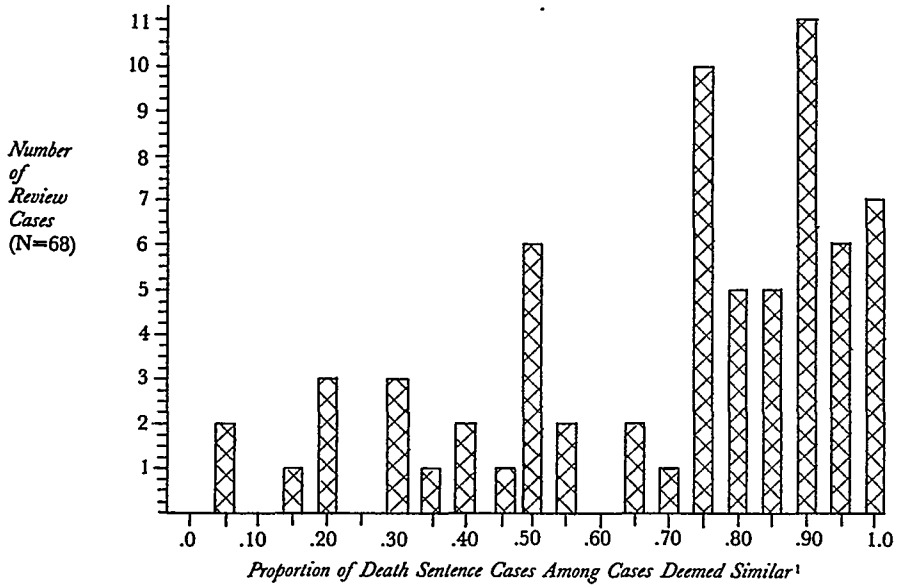

II. MAIN DETERMINANTS METHOD

FREQUENCY

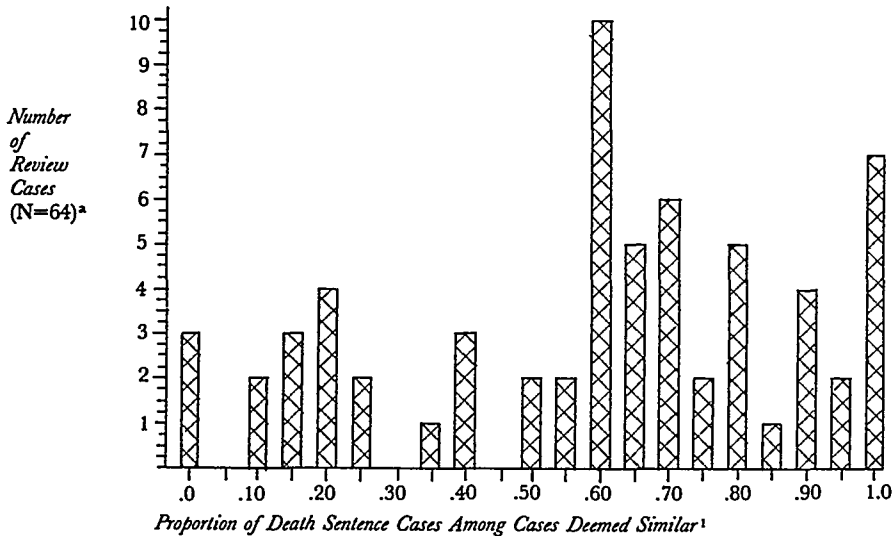

² Frequencies could not be calculated for four cases because of inadequate sample size.

¹ Except for .0 and 1.0, points on the scale include cases with the proportion indicated plus cases immediately above the next lower point on the scale, e.g., the bar at .50 represents cases with death sentencing frequencies among similar cases ranging from more than .45 to and including .50.

selected as similar by this method was .58. Furthermore, using this method, only thirty percent of the death sentence cases included in the study qualified as presumptively evenhanded (19/64), while twenty-two percent (14/64) qualified as presumptively excessive.

B. THE SOURCES OF COMPARATIVE EXCESSIVENESS

There appear to be two principal explanations for Georgia's generally low death-sentencing rates. The first is that prosecutors do not routinely seek death sentences in death-eligible cases. In fact, in only forty percent of the cases in which the jury convicted the defendant of a murder involving a statutory aggravating circumstance did the prosecution even seek a death sentence.¹²⁷ Although the Georgia statute states that there "shall" be a penalty trial in all cases resulting in a murder conviction, in practice a penalty trial will not occur unless the prosecution so requests.¹²⁸ The impact of this exercise of prosecutorial discretion to forego a penalty trial is enormous. When penalty trials do occur, Georgia juries impose death sentences in fifty-five percent of the cases; among

¹²⁷ As the data in Table 4 below indicate, however, there is a strong correlation between the rate at which penalty trials are held and the seriousness of the cases.

TABLE 4

RATES AT WHICH CASES ADVANCE TO A PENALTY TRIAL, CONTROLLING FOR THE NUMBER OF STATUTORY AGGRAVATING FACTORS AND THE PREDICTED LIKELIHOOD OF A DEATH SENTENCE

<u>A</u>	<u>B</u>	<u>C</u>	<u>D</u>
Number of Statutory Aggravating Factors in the Cases ^a	Penalty Trial Rate	Predicted Likelihood of a Death Sentence from 1 (low) to 8 (high) ^b	Penalty Trial Rate
0	.06 (8/132)	1	.03 (1/36)
1	.11 (17/150)	2	.11 (22/207)
2	.35 (47/136)	3	.23 (31/136)
3	.63 (62/99)	4	.49 (43/87)
4	.73 (45/62)	5	.49 (25/51)
5	.77 (10/13)	6	.86 (30/35)
6	.50 (1/2)	7	.73 (11/15)
		8	1.0 (27/27)

^a The correlation between this measure and the penalty trial rate is .52.

^b See *supra* note 98 and accompanying text for an explanation of how this index and scale were created. The correlation between this measure and the penalty trial rate is .56.

¹²⁸ See *supra* note 56.

the more aggravated cases the death-sentencing rates are particularly high.¹²⁹

Georgia's relatively low overall post-*Furman* death-sentencing rate also reflects a very low death-sentencing rate in black victim cases.¹³⁰

¹²⁹ Table 5 below presents death-sentencing rates at penalty trial controlling for the number of statutory aggravating factors and the predicted likelihood of a death sentence.

TABLE 5

I. Penalty Trial Death Sentencing Rates Controlling for the Number of Statutory Aggravating Factors and the Predicted Likelihood of a Death Sentence

<u>A</u>	<u>B</u>	<u>C</u>	<u>D</u>
Number of Statutory Aggravating Factors in the Cases ^a	Death Sentencing Rate	<u>Predicted Likelihood of a Death Sentence</u>	
		from 1 (low) to 8 (high) ^b	Death Sentencing Rate
0	.0 (0/8)	1	.00 (0/1)
1	.33 (6/18)	2	.00 (0/22)
2	.37 (18/49)	3	.29 (9/31)
3	.62 (40/65)	4	.33 (15/46)
4	.77 (39/51)	5	.70 (19/27)
5	.82 (9/11)	6	.87 (27/31)
6	1.00 (1/1)	7	.91 (10/11)
		8	.97 (33/34)

II. Number and Proportion of Death Sentence Cases for Which the Death Sentencing Frequency in Similar Cases was:

A. Less than .35	.05 (6/113)	.21 (24/113)
B. .80 or More	.09 (10/113)	.62 (70/113)

^a The correlation between this measure and the penalty trial death sentencing rate is .40.

^b See *supra* note 98 and accompanying text for an explanation of how this index was created.

¹³⁰ Three measures of race-of-victim disparities among cases resulting in a murder conviction at trial are shown in Table 6. Because black victim cases constitute 40% of the cases in the sample, the very low death-sentencing rate among those cases draws down the overall rate. We also measured the overall race of victim disparity with an O.L.S. regression analysis which controlled simultaneously for over 150 aggravating and mitigating factors, and the defendants age, sex, race and socio-economic status. The race of victim coefficient in the analysis was .09, statistically significant at the .02 level. The adjusted R² of the analysis was .57.

TABLE 6
RACE OF VICTIM DISPARITIES IN DEATH SENTENCING RATES ESTIMATED WITH THREE MEASURES

I. NUMBER OF STATUTORY AGGRAVATING FACTORS				II. PREDICTED LIKELIHOOD OF A DEATH SENTENCE (PRE- & POST-FURMAN DATA) ^b				III. PREDICTED LIKELIHOOD OF A DEATH SENTENCE (POST-FURMAN DATA ONLY) ^d											
Number of Statutory Aggravating Factors	A		D		E		F	I		J		K	M		N	O			
	White Victim Rate	Black Victim Rate	Arithmetic Difference (White Victim Rate)	Col.B-Col.C ^a	Ratio (White Victim Rate/Black Victim Rate)	Col.B/Col.C		Predicted Likelihood of a Death Sentence	White Victim Rate	Black Victim Rate	Arithmetic Difference (White Victim Rate)		Col.G-Col.H ^c	Ratio (White Victim Rate/Black Victim Rate)			Col.G/Col.H	White Victim Rate	Black Victim Rate
0	.0	.0	0	0	.	.	1	.0	0	.	.	1	.0	.0	0	1.0			
	(0/56)	(0/76)						(0/26)	(0/10)				(0/43)	(0/40)					
1	.05	.01	.04	.04	5	5	2	.0	0	.	.	2	.01	.0	.01	.			
	(4/78)	(1/72)						(0/95)	(0/112)				(1/90)	(0/107)					
2	.11	.12	-.01	-.01	.92	.92	3	.12	.12	.	.	3	.04	.02	.02	2.0			
	(9/79)	(7/57)						(9/74)	(0/62)				(3/81)	(1/51)					
3	.46	.19	.27*	.27*	2.42*	2.42*	4	.18	.07	.11	.11	4	.26	.15	.11	1.7			
	(31/68)	(6/31)						(10/57)	(2/30)				(12/46)	(5/33)					
4	.60	.11	.49*	.49*	5.46*	5.46*	5	.38	.27	.11	.11	5	.55	.43	.12	1.3			
	(32/53)	(1/9)						(11/29)	(6/22)				(16/29)	(3/7)					
5 + 6	.64	.0	.64	.64	.	.	6	.79	.50	.29	.29	6	.78	.67	.11	1.2			
	(9/14)	(0/1)						(23/29)	(3/6)				(14/18)	(4/6)					
							7	.62	1.0	-.38	-.38	7	.88	1.0	-.12	.88			
								(8/13)	(2/2)				(15/17)	(1/1)					
							8	.96	1.0	-.04	-.04	8	1.8	1.0	0	.1			
								(24/25)	(2/2)				(24/24)	(1/1)					

a The race of victim disparity overall is .08, statistically significant at the .01 level.
 b See *supra* note 99 for a description of this measure.
 c The race of victim disparity overall is .06, statistically significant at the .01 level.
 d See *supra* note 104 for a description of this measure.
 e The race of victim disparity overall is .03, statistically significant at the .12 level.

Specifically, the rate is .06 (15/246) for black victim cases versus .24 (85/348) for white victim cases. This disparity is particularly apparent when prosecutors are deciding whether to seek a death sentence, and its effect persists after one adjusts for the aggravation level of different cases.¹³¹ In other words, our data strongly suggests that Georgia is oper-

¹³¹ Table 6A presents the race-of-victim disparities in prosecutorial decision-making controlling for the number of statutory aggravating factors.

TABLE 6A
RACE OF VICTIM DISPARITIES IN PROSECUTORIAL DECISIONMAKING

<u>A</u>	<u>B</u> Penalty Trial Rates		<u>D</u>	<u>E</u>
Number of Statutory Aggravating Factors	White Victim Rate	Black Victim Rate	Arithmetic Difference Penalty Trial Rates (Col.B.-Col.C) ^a	Ratio Penalty Trial Rates (Col.B.-Col.C)
0	.13 (7/56)	.01 (1/76)	.12*	13.00
1	.17 (13/78)	.06 (4/72)	.11	2.83
2	.39 (31/79)	.28 (16/57)	.11	1.39
3	.74 (50/68)	.39 (12/31)	.35**	1.90
4	.81 (43/53)	.22 (2/9)	.59**	3.68
5 or 6	.71 (10/14)	1.00 (1/1)	-.29	.71

*Statistically significant beyond the .05 level.

**Statistically significant beyond the .01 level.

^a The overall race-of-victim disparity was .17, statistically significant at the .0001 level.

We also measured race-of-victim disparities in prosecutorial decisionmaking after controlling for several other combinations of nonracial background factors. We created an index of legitimate variables statistically significant at the .10 level with ordinary least squares procedures, using the decision to conduct a penalty trial hearing as the outcome variable; the index was also limited to variables whose coefficients were in the expected direction as explained *supra* note 98. When this index was controlled for, along with the race of defendant, the ordinary least squares coefficient was .12, statistically significant at the .001 level. The logistic regression coefficient was 1.02, significant at the .002 level, suggesting that the odds of having a penalty trial are 2.7 times higher if the defendant's victim is white. We also created indices using logistic regression procedures, with and without perverse variables. The results were comparable, producing ordinary least square coefficients of .15 ($P = .001$) and .16 ($P = .001$) and logistic coefficients producing enhanced odds of having a penalty trial on the order 2.7 ($P = .001$) and 3.2 ($P = .001$) times. We also conducted a large scale ordinary least squares (O.L.S.) regression analysis which controlled simultaneously for over 150 aggravating and mitigating background facts, and the age, sex, race, and socio-economic status of the defendant. The race-of-victim coefficient in the analysis was .12 statistically significant at the .01 level. When we controlled for all 10 statutory aggravating circumstances, a prior record variable, and 80 mitigating factors, the race-of-victim coefficient was .10, significant at the .001 level. When we controlled simultaneously for over 200 legitimate and suspect background factors, the race-of-victim coefficient dropped to .11, significant at the .15 level.

ating a dual system, based upon the race of the victim, for processing homicide cases. Georgia juries appear to tolerate greater levels of aggravation without imposing the death penalty in black victim cases;¹³² and, as compared to white victim cases, the level of aggravation in black victim cases must be substantially greater before the prosecutor will even seek a death sentence.

C. COMPARATIVE SENTENCE REVIEW IN THE GEORGIA SUPREME COURT

The United States Supreme Court asserted in *Gregg v. Georgia* that

When the analysis was limited to variables that were statistically significant at the .10 level, the coefficient for the race-of-victim variable was .13, significant at the .0001 level. The leading source of the race-of-victim disparities in Georgia's death-sentencing system for defendants convicted of murder at trial is clearly the decision to advance the case to a penalty trial.

¹³² Table 7 presents the race-of-victim disparities in jury decisionmaking controlling for the number of statutory aggravating factors.

TABLE 7
RACE-OF-VICTIM DISPARITIES IN JURY DECISIONMAKING

<u>A</u>	<u>B</u> Death-Sentencing Rate		<u>D</u>	<u>E</u>
Number of Statutory Aggravating Factors	White Victim Rate	Black Victim Rate	Arithmetic Difference Death- Sentencing Rates (Col.B-Col.C) ^a	Ratio Death- Sentencing Rates (Col.B/Col.C)
0	.00 (0/7)	.00 (0/1)	0	-
1	.36 (5/14)	.25 (1/4)	.11	1.44
2	.31 (10/32)	.47 (8/17)	-.16	.66
3	.64 (34/53)	.50 (6/12)	.14	1.28
4	.78 (38/49)	.50 (1/2)	.28	1.56
5 or 6	.91 (10/11)	.00 (0/1)	.91	-

^a The overall race-of-victim disparity was .05, statistically significant at the .59 level.

We also measured race-of-victim effects in jury sentencing decisionmaking with ordinary least squares (O.L.S.) and logistic regression analyses. In an O.L.S. analysis which controlled simultaneously all statutory aggravating circumstances, some 50 mitigating factors and the race of defendant, the race-of-victim coefficient was .22 (significant at the .04 level); in a stepwise regression analysis which included the statistically significant (< 10) aggravating and mitigating factors selected from a list of over 150 variables the race-of-victim coefficient was .06, significant at the .42 level. Logistic analysis with smaller sets of the most important non-racial background variables showed slightly enhanced odds of receiving a death sentence in white victim cases (by factors of from 1.2 to 1.8), although none of these disparities achieved statistical significance beyond the .10 level. These results indicate that statewide, a race-of-victim effect is perceivable but weak.

the Georgia Supreme Court's system of comparative sentence review ensured that defendants would be protected against arbitrary, capricious, or discriminatory death sentences. Since 1973, the Georgia court has conducted comparative sentence reviews in over 120 death penalty cases, including the sixty-eight cases included in this study. In only two of these 120 cases, however, has the Georgia court vacated death sentences on the grounds that they were "excessive or disproportionate." Moreover, in neither of these two cases did the court vacate the death sentence because of the rare or infrequent imposition of that penalty in similar cases. In one case the jury had resentenced to death a defendant who had previously received a life sentence;¹³³ in the other, the defendant's copерpetrator, the actual triggerman, had received only a life sentence.¹³⁴ In every other case, including the sixty-eight cases included in our study, the Georgia Supreme Court affirmed the death sentence as neither excessive nor disproportionate.

This fact alone, however, does not suggest that the Georgia court's comparative review process is in any way defective. The results of that review process are quite proper if the cases cited in the appendices to the court's opinions in the sixty-eight death sentence cases in our study were the proper cases to consider for comparative sentence review. Figure 4 depicts the distribution of death-sentencing frequencies among these appendix cases. It indicates that for eighty-eight percent of these cases, (60/68), every case cited as similar in the court's appendices was a death sentence case. For only five of these sixty-eight cases was the death-sentencing rate among the appendix cases less than .75; and for only one case was it under .50.¹³⁵ The issue, however, is whether the cases that

¹³³ *Ward v. State*, 239 Ga. 205, 208-09, 236 S.E.2d 365, 368 (1977). The decision drew an interesting dissent in which Justice Bowles argued that all similar cases, not just the defendant's prior case, should have been considered on the issue of disproportionality. The rule of the Georgia Supreme Court in *Ward* was adopted by the United States Supreme Court in *Bullington v. Missouri*, 451 U.S. 430, 437 (1981), on the ground that the double jeopardy clause prevented imposition of a death sentence upon retrial when a jury had imposed life imprisonment at the first trial.

¹³⁴ *Hall v. State*, 241 Ga. 252, 244 S.E.2d 833 (1978). The Georgia court has not, however, established a *per se* rule to the effect that a death sentence is disproportionate in all cases in which copерpetrators receive life sentences. The question turns upon who the triggerman was, how clear it was who the triggerman was, and whether the copерpetrator who received less than a death sentence did so at a penalty trial, or by way of a plea bargain, or up on the basis of other distinguishing characteristics. See also *Dick v. State*, 246 Ga. 697, 707-08, 273 S.E.2d 124, 134 (1980); *Baker v. State*, 243 Ga. 710, 712-13, 257 S.E.2d 192, 194 (1979); *Hill v. State*, 237 Ga. 794, 801-03, 229 S.E.2d 737, 742-43 (1976).

In both *Ward* and *Hall*, the court appears to have been applying a concept of intra-case proportionality that rests upon a notion of fairness that goes beyond the concept underlying the prohibition against excessive and disproportionate death sentences generally. No reason is given in either case for the deviation from the more general approach except a concept of "equal justice" in the treatment of offenders in a single crime.

¹³⁵ See *supra* notes 107-17 and accompanying text for a discussion of how infrequently

FIGURE 4
 DISTRIBUTION OF 68 DEATH SENTENCE CASES REVIEWED BY THE
 GEORGIA SUPREME COURT FOR EXCESSIVENESS OR DISPROPORTION-
 ALITY ACCORDING TO THE PROPORTION OF DEATH SENTENCED
 CASES AMONG THE CASES IDENTIFIED AS SIMILAR IN THE COURT'S
 APPENDIX

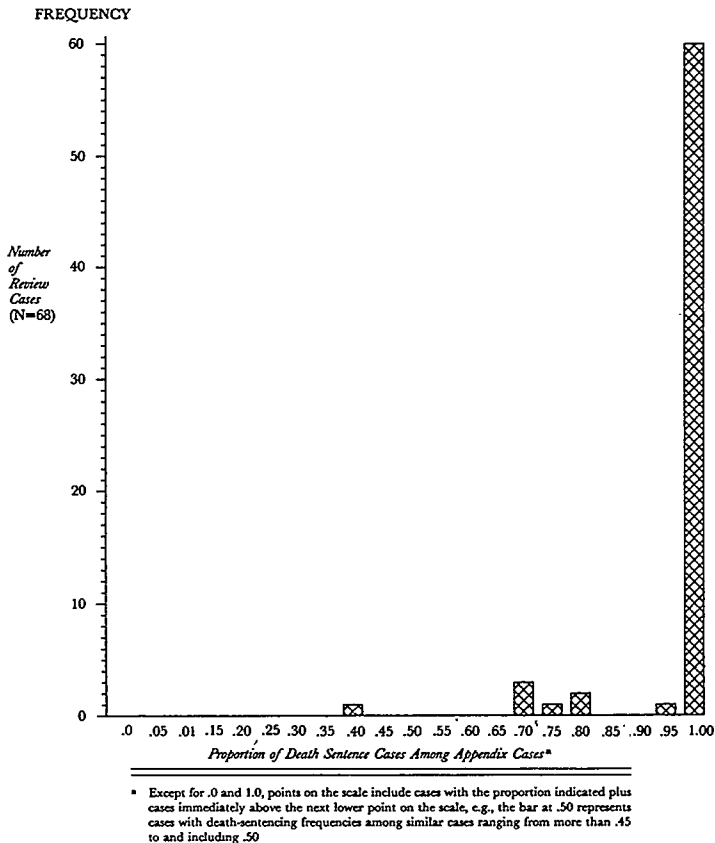

lected as “similar” when reviewing death penalty cases are, in fact, the cases it should consider when conducting such comparative sentence reviews.

D. EVALUATION

A comparison of the results of our analyses of the sixty-eight death sentence cases in our study with the Georgia Supreme Court’s failure to find that even one of those sixty-eight death sentences was comparatively excessive strongly suggests that Georgia’s sentence review process does not function as the Court in *Gregg v. Georgia* assumed. We make this statement cautiously, however, since its accuracy depends on the validity of our measures of comparative excessiveness. A possibility does

death sentences must be imposed among similar cases to constitute excessiveness in a comparative sense.

exist that the observed disparity between the Georgia court's record and our findings has simply resulted from our use of inaccurate or inappropriate measures. As previously noted, the critical feature of any system of comparative sentence review is the process of selecting the cases deemed to be "similar" to the death sentence case under review. As we have also noted, none of the computer-assisted methods we have employed for that purpose is foolproof. An examination of those special, nonquantifiable features of any case we cannot include in our computerized data files may change our results.

We consider this prospect unlikely, however. Our data files include every factor that the Georgia Supreme Court has identified as salient in any of its opinions. We also doubt that the Georgia Supreme Court has reached different conclusions about the degree of excessiveness involved in any particular case from those indicated by our results on the basis of obscure or unquantifiable factual distinctions. Certainly, the court's opinions have never invoked any idiosyncratic features of the death sentence cases under review that were not apparent from the face of the record or did not appear in our list of variables.

It is more likely, we believe, that the discrepancies between our findings and the court's sentence review decisions have resulted from the manner in which the court conducts the sentence review process. There are several aspects of the court's similar case selection procedures that could contribute to this disparity in results, each of which we discuss later in this Article. We consider first, however, an alternate hypothesis: that the Georgia Supreme Court conducts a *de facto* sentence review in death penalty cases by reversing on procedural grounds death sentences it considers to be comparatively excessive.

1. *The De Facto Review Hypothesis*

The Georgia Supreme Court has never vacated a death sentence in a murder case because of the infrequency of death sentences in similar cases. There is a possibility, however, that the court in effect conducts a *de facto* comparative sentence review by reversing death sentences it regards as excessive on procedural grounds.¹³⁶ The court vacates on procedural grounds approximately twenty percent of the death sentences it reviews, either by reversing the underlying murder conviction or vacating the death sentence for procedural error affecting the penalty trial. It is possible, therefore, for institutional or other reasons, that the court

¹³⁶ The hypothesis was suggested by Dix, *Appellate Review of the Decision to Impose Death*, 68 GEO. L.J. 97, 118 (1979) (the court may be using "procedural defects to justify the reversal of death sentences that it finds offensive for unarticulated but more 'substantive' reasons").

only engages in a formal comparative sentence review in cases it believes are clearly not excessive or disproportionate in a comparative sense.

TABLE 8
RATES AT WHICH DEATH SENTENCES ARE VACATED ON APPEAL ON PROCEDURAL GROUNDS, CONTROLLING FOR THE PREDICTED LIKELIHOOD OF A DEATH SENTENCE

<u>A</u> Predicted Likelihood of a Death Sentence from 3 (lowest) to 8 (highest) ^a	<u>B</u> Reversal Rates
3	.43 (3/7)
4	.36 (4/11)
5	.25 (4/16)
6	.12 (3/26)
7	.20 (2/10)
8	.23 (6/26)

^a See *supra* note 98 and accompanying text for a description of the index underlying this scale. Levels 1 & 2 are omitted from the scale because no death sentences were imposed among cases at those levels.

If this hypothesis were true, one would expect to see higher rates of reversal on procedural grounds among the less aggravated death sentence cases.¹³⁷ Table 8 depicts the reversal for death sentence cases at different levels of aggravation. Except between levels six and seven the reversal rate generally declines as the cases become more aggravated: among the most aggravated cases, the reversal rate is approximately one-half that observed among the least aggravated cases.¹³⁸

Table 9 depicts the extent to which the procedural reversals of death sentences have reduced the level of excessiveness in the system, as

¹³⁷ This expectation rests upon the assumption that a death sentence in a less aggravated class of cases is more likely to be comparatively excessive.

¹³⁸ It should be noted, however, that between categories three, four, and five on the index-based scale there were four death sentences imposed by a jury which were changed to life sentences at the trial level, and the case was not appealed to the Georgia Supreme Court. We can only surmise that concerns about excessiveness influenced those decisions. Since the data in Table 8 are limited to cases that were appealed to the Georgia Supreme Court, the impact of those decisions is not reflected in Table 8.

estimated with an index measure. Columns B and C indicate the number and proportion of death sentence cases before and after appellate review at each aggravation level. Of particular interest are the death sentence cases included in levels three to five for which the death-sentencing frequency is less than .35. Column B indicates that there were originally thirty-eight death sentence cases in this potentially excessive category. Column D indicates, however, that the Georgia Supreme Court reversed fifteen of these cases on procedural grounds, reducing the size of the group by thirty-nine percent.

TABLE 9
DEATH-SENTENCING RATES AMONG GROUPS OF SIMILAR CASES
BEFORE AND AFTER APPELLATE REVIEW

<u>A</u>	<u>B</u>	<u>C</u>	<u>D</u>
Predicted Likelihood of Receiving a Death Sentence from 3 (lowest) to 8 (highest) ^a	Before Review	After Review	Reduction In the Number of Death Cases After Appellate Review (Col.B-Col.C)
3	.07 (9/136)	.03 (4/131)	5
4	.14 (12/87)	.09 (7/82)	5
5	.33 (17/51)	.26 (12/46)	5
6	.74 (26/35)	.72 (23/32)	3
7	.67 (10/15)	.62 (8/13)	2
8	.96 (26/27)	.95 (20/21)	6

^a See *supra* note 98 and accompanying text for a description of the index underlying this scale. Levels 1 & 2 are omitted from the scale because no death sentences were imposed among cases at those levels.

Thus, our data provide some support for the hypothesis that the Georgia court conducts *de facto* comparative sentence reviews by vacating excessive death sentences on procedural grounds. Certainly, by these decisions the court has eliminated a not insubstantial portion of the death sentences which our measures suggest may be comparatively excessive. On the other hand, it also seems likely that the Georgia Supreme Court's appellate review processes has left untouched a substantial number of cases which may be excessive. We believe these cases remain uncorrected because of certain institutional features of the Georgia Supreme Court's procedures for selecting "similar" cases. We now address whether comparatively excessive death sentencing persists de-

spite the Georgia Supreme Court's appellate review, and we examine certain policies that the Georgia court has apparently adopted that may contribute to that result.

2. *The Death Case Bias Hypothesis*

Despite the statutory requirement of comparative sentence review, the Georgia Supreme Court does not vacate on excessiveness grounds death sentences which our measures identify as questionable. This discrepancy in results occurs because the Georgia court selects as "similar" different cases from those identified by our measures. One possible explanation for this variation is that there is a death case bias in the court's method for identifying similar cases. To test this hypothesis, we calculated the rates at which the Georgia court included life and death cases from pools of presumptively similar cases in its appendices. We then compared those rates with the rates at which our three alternative measures selected life and death cases as similar from the same pools of presumptively similar cases.

We conducted a separate analysis for each of the sixty-eight death sentence cases included in our study. We constructed a pool of presumptively similar cases for each of these sixty-eight cases by combining the cases identified as similar by the court in its appendices with the cases our three alternative measures identified as similar; we gave each case identified as similar by any method equal weight.¹³⁹

In order to test the Georgia Supreme Court's appendix cases for a death case bias, we began with the assumption that any unbiased method of identifying similar cases is as likely to overlook comparable life sentence cases as comparable death sentence cases. If the method operates without a systematic bias, its tendency disproportionately to select either death or life sentence cases should vary from case to case in a random fashion.¹⁴⁰

Thus, for each of the sixty-eight death sentence cases in our study, we calculated the extent to which the court's appendix cases and those

¹³⁹ Our analysis, however, deviated from the procedure used by the court in the following particulars: (1) our universe of potentially similar cases was somewhat smaller than that considered by the court, *see supra* note 88, and (2) the analysis conducted with the fact-specific main determinants measure included as potentially similar cases only post-*Furman* decisions. The analysis of the pre-*Furman* case hypothesis suggests that the exclusion of the pre-*Furman* cases from the universe of potentially similar cases has little impact on the results. *See infra* note 155 and accompanying text.

¹⁴⁰ This is the same assumption relied on by courts when analyzing claims of systemwide discriminations. When choosing among similarly situated employees or jurors of different races or sexes, it is to be assumed that in certain cases random factors will result in an overrepresentation of women or minorities and in other cases underrepresentation of women and minorities, but that the degree of over and underselection of the two groups should be randomly distributed. *See* D. BALDUS & J. COLE, *supra* note 105, at 287-321.

selected by our alternative methods tended disproportionately to select as similar life sentence or death sentence cases. We measured selection bias by the difference between the rates at which a given method selected life sentence and death sentence cases from this pool. For example, assume that, for a given death sentence case, the pool of presumptively similar cases consists of twenty death cases and thirty life cases. If a particular selection method, the main determinants method, for example, identified as similar ten death cases and ten life cases, the selection rate for death sentence cases would be .50 (10/20), and the rate for the life cases would be .33 (10/30). Thus, for this case the main determinants method overselected death cases by a margin of .17 (.50 rate for death cases, .33 rate for life cases). For each of the sixty-eight cases we used this method to determine the rates at which the court overselected death and life cases as similar; we made similar computations for each of our three alternative methods. Thus, for each of the sixty-eight cases we derived a set of four disparities, each reflecting the rates at which different selection methods identified life and death cases as similar.

Table 10 shows the results.¹⁴¹ They indicate that the Georgia Supreme Court has a strong tendency to overselect death sentence cases. In fact, the Georgia Supreme Court selected as "similar" only one case decided under the post-*Furman* statute in which the defendant received a life sentence. Interestingly, Table 10 suggests that the salient factors method, which the court most regularly purports to use, possesses a moderate bias in favor of life sentence cases.

Figure 5 illustrates the distribution of the disparities summarized in Table 10. For example, panel I of Figure 5 shows the number of times death cases were favored over life cases and the degree of the bias for each of the court's appendix cases. The disparities produced by the two index-related measures, illustrated in panels III and IV, show a fairly random pattern of disparities; there are about as many groups of similar cases in which life cases are overrepresented as there are overrepresentations of death sentence cases. These panels illustrate exactly the kind of distribution one would expect from an unbiased selection procedure. The distribution for the salient factors method (panel II) shows a slight

¹⁴¹ The results in Table 10 should be viewed as only suggestive, since the sizes of the pools of similar cases selected by each method are not the same. The largest groups of similar cases were selected by the index method (average 26) followed by the Georgia court's appendices (average 15), the salient feature method (average 14), and the fact-specific main determinants method (average 9). To the extent that a particular method identifies a very large number of cases as similar, it increases the likelihood that other methods will also identify as similar the cases it selected.

TABLE 10
 AVERAGE DISPARITY IN THE RATES AT WHICH DEATH SENTENCE
 AND LIFE SENTENCE CASES ARE IDENTIFIED AS SIMILAR FOR
 PURPOSES OF COMPARATIVE SENTENCE REVIEW^a

<u>Method</u>	<u>Average Disparity in Selection Rates (Death Case Rate—Life Case Rate)</u>
Georgia Supreme Court Method as Reflected in Appendix Cases	.42
Index Method	.14
Main Determinants Method	-.10
Salient Factors Method	-.24

^a N=68

bias in favor of life cases, and the distribution for the appendix cases (panel I) shows a strong bias toward the overselection of death cases. What is most compelling, however, is the failure of the Georgia Supreme Court's appendix cases to overselect life sentence cases with respect to even one of the sixty-eight death sentence cases in our study.

Finally, we compared the identity of the cases selected as similar by the court and the alternative methods. The results do not suggest that the Georgia court is working with an entirely different universe of potentially similar cases from that identified by our alternate methods. Indeed, the court has identified as "similar" many of the same death sentence cases selected by our alternative methods. The court, however, systematically overlooks the life sentence cases identified as similar by our alternative methods.

3. Possible Sources of Death Case Bias

The results of our analyses suggest that the Georgia court's sentence review process is systematically biased towards overselecting cases in which the jury imposed a death sentence as "similar." As a consequence, no death sentence reviewed by the court appears to be excessive. There are several possible explanations for the Georgia court's predisposition to overselect death sentence cases, each of which we attempted to evaluate.

FIGURE 5

FOUR DISTRIBUTIONS OF 68 DEATH SENTENCE CASES REVIEWED BY THE GEORGIA COURT FOR COMPARATIVE EXCESSIVENESS ACCORDING TO THE DEGREE OF BIAS REFLECTED IN THE CASES IDENTIFIED AS SIMILAR BY THE GEORGIA COURT AND THREE ALTERNATIVE METHODS OF IDENTIFYING SIMILAR CASES FOR COMPARATIVE SENTENCE REVIEW

(Values along the horizontal axis of each figure indicate the degree to which death (+) or life (-) cases were disproportionately represented among the cases identified as similar)*

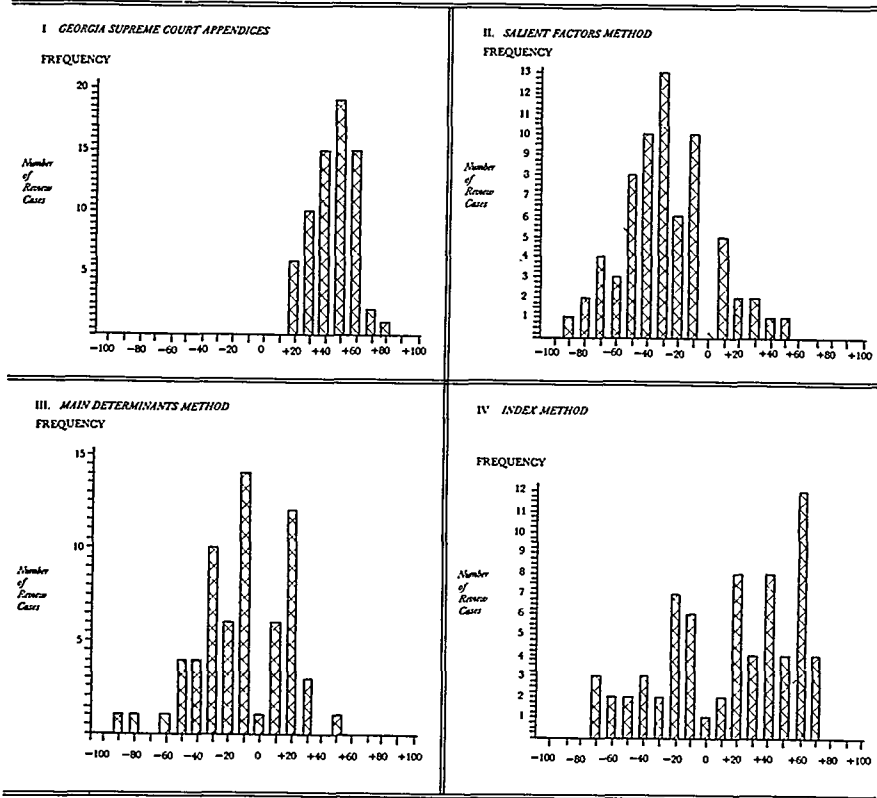

* Points on the scale include cases with the disparity indicated plus cases immediately above the next lower point on the scale, e.g., the bar at 40 in Panel I represents cases with a measured bias of from more than 45 to and including 50.

a. A precedent-seeking approach to proportionality review

One possible explanation is that the Georgia Supreme Court frequently uses a precedent-seeking form of sentence review and is satisfied, on the basis of even a few "similar" death sentence cases, that the death sentence in a particular case is reasonable. The principal evidence supporting this hypothesis is the small number of life sentence cases listed in the court's appendices as "similar." In only seven of the sixty-eight death sentence cases in our study did the court's opinion identify a life sentence case as "similar."

One can readily understand why a court might employ a precedent-seeking approach to sentence review. Collecting and systematically analyzing data case-by-case can be a complex, time-consuming process. Moreover, except when a death sentence is clearly excessive, the process may involve difficult questions of interpretation for which there is little guidance.¹⁴² The precedent-seeking approach is easier to apply and may avoid hard legal issues.¹⁴³ Furthermore, in comparison to the frequency approach characteristic of true comparative sentence review, the precedent-seeking approach more closely resembles the methodology of conventional legal research and analysis and seems more comfortable to the law-trained mind. The danger, however, is that the precedent-seeking approach usually fails to identify all the cases in the universe of potentially similar cases that are comparable to the death sentence case under review.

b. The penalty trial requirement hypothesis

Another possible explanation for the death case bias is that the Georgia Supreme Court may limit the universe of potentially similar post-*Furman* cases to only those in which there was a penalty trial. As noted earlier, some of the Georgia Supreme Court's opinions suggest that the comparative sentence review process should consider only jury sentencing decisions.¹⁴⁴ Furthermore, the actual composition of the cases that the Georgia Supreme Court's appendices identifies as similar is consistent with the effect of such a restriction. In fact, the appendices to the court's opinions in the sixty-eight death sentence cases in our study list only one post-*Furman* case which did not involve a penalty trial, and all those that did resulted in a death sentence.¹⁴⁵

¹⁴² See *supra* text accompanying note 38.

¹⁴³ The most difficult issues involve: (a) the specification of the universe of potentially similar cases, (b) the specification of appropriate and nonappropriate factors with which to identify similar cases, and (c) how infrequent death sentencing must be among similar cases before an individual sentence is deemed excessive.

¹⁴⁴ See *supra* note 55 and accompanying text.

¹⁴⁵ Pre-*Furman* life cases were cited in seven of the appendices of the 68 cases reanalyzed in

If the Georgia Supreme Court is, in fact, implementing a penalty trial requirement when selecting its universe of potentially similar cases, the constitutional implications of that policy deserve emphasis. As previously mentioned, the United States Supreme Court sustained the constitutionality of the Georgia capital sentencing statute in *Gregg* because a majority of the Court believed Georgia's statutory procedures could prevent arbitrary and capricious death sentences. The Court also identified Georgia's system of comparative sentence review as an important safeguard against excessive or discriminatory death sentences. However, the Court reached that conclusion based on an apparent assumption that, as Georgia law seemed to require, a penalty trial would occur in every case in which the defendant was convicted of capital murder.¹⁴⁶ Furthermore, if the assumption is correct, a penalty trial requirement would be redundant; if every capital conviction resulted in a penalty trial, then the universe of potentially similar cases would include the sentence imposed on every convicted capital defendant. Thus, the comparative sentencing review process would operate upon the basis of every sentencing decision in every capital case.¹⁴⁷

In fact, however, not every case in which the jury convicts the defendant of capital murder results in a penalty trial. Penalty trials occur in only forty percent of such cases. In this respect alone, a penalty trial requirement would exclude from the universe of potentially similar cases a substantial number of capital convictions, all of which resulted in life sentences.

A further distortion occurs because defendants who receive life sentences following penalty trials are less likely to appeal than defendants who received life sentences without undergoing penalty trials (.62 versus .71).¹⁴⁸ This statistic is important because the Georgia Supreme Court also limits the universe of potentially similar cases to those in

this study. The single post-*Furman* case cited not involving a penalty trial was *Hill v. State*, 237 Ga. 610, 229 S.E.2d 419 (1976), listed in the appendix of *Dix v. State*, 238 Ga. 209, 217, 232 S.E.2d 47, 52 (1977).

¹⁴⁶ The Georgia statute states that "[i]n all cases in which the death penalty may be imposed and which are tried by a jury, upon a return of a verdict of guilty by the jury, the court shall resume the trial and conduct a presentence hearing before the jury." GA. CODE ANN. § 27-2503(b) (1983). In the event of a guilty plea to murder, the court conducts the penalty trial and passes sentence. GA. CODE ANN. § 27-2528.

¹⁴⁷ Since the decisions of prosecutors not to seek a death sentence and of juries not to impose a death sentence when it is sought by the prosecutor are subject to no direct review by the Georgia court, comparative sentence review provides the sole basis for reviewing, albeit indirectly, the impact of those decisions on the evenhandedness of the state's death-sentencing system.

¹⁴⁸ During part of the time period considered in this study, defendants convicted of capital murder and sentenced to life imprisonment exposed themselves to the possibility of a death sentence if a successful appeal resulted in a new trial and reconviction. *Bullington v. Missouri*, 451 U.S. 430 (1981), has since eliminated this possibility on constitutional grounds.

which the defendant appealed.¹⁴⁹ When combined, the penalty trial requirement and the appeal requirement would operate together to exclude from the universe of potentially similar cases eighty-four percent of the capital convictions in which the defendant received a life sentence. As a consequence, the theoretical efficacy of comparative sentence review in Georgia—an important factor in the *Gregg* decision—would be substantially diminished.

In order to test the effects of a penalty trial requirement, we compared death-sentencing frequencies among groups of post-*Furman* cases selected as similar by an index method, first including all life sentence cases in the universe of potentially similar cases and then including only life sentence cases that included penalty trial. Table 11 depicts the results of this analysis. Column D of Table 11 indicates the disparity in death-sentencing rates among the two groups of cases. It suggests that, except in the most aggravated cases, the penalty trial requirement in-

TABLE 11
AVERAGE DEATH-SENTENCING FREQUENCIES AMONG GROUPS OF
APPEALED CASES WHEN ALL LIFE SENTENCE CASES ARE INCLUDED
AND WHEN ONLY PENALTY TRIAL LIFE SENTENCE CASES ARE
INCLUDED IN THE ANALYSIS, CONTROLLING FOR THE PREDICTED
LIKELIHOOD OF RECEIVING A DEATH SENTENCE

<u>A</u>	<u>B</u>	<u>C</u>	<u>D</u>	<u>E</u>
Predicted Likelihood of Receiving a Death Sentence from 3 (lowest) to 8 (highest) ^a	All Appealed Cases	Only Appealed Cases With Penalty Trial	Disparity (Col.C-Col.B)	Ratio (Col.C-Col.B)
3	.07 (7/101)	.32 (7/22)	.25*	4.6
4	.21 (11/52)	.37 (11/30)	.16	1.8
5	.39 (16/41)	.84 (16/19)	.45*	2.1
6	.81 (26/32)	.93 (26/28)	.12	1.2
7	.67 (10/15)	.91 (10/11)	.24	1.4
8	.96 (26/27)	.96 (26/27)	.0	1.0
Average ^b	.52	.72	.20	0.2

^a See *supra* note 98 and accompanying text for a description of the index underlying this scale. Levels 1 & 2 are omitted from the scale because no death sentences were imposed among cases at those levels.

^b Calculated by dividing the sum of the proportions in each column by 6 (levels 3 through 8).

*Statistically significant beyond the .05 level.

Ward v. State, 239 Ga. at 208-09, 236 S.E.2d at 368, eliminated this possibility when the first life sentence was imposed by a jury.

¹⁴⁹ See *infra* note 160 and accompanying text.

creases the proportion of death sentence cases within these groupings of similar cases by more than twenty percent. An additional analysis, not reported here, that used the salient features method for identifying similar cases showed the same degree of disparity in death-sentencing rates.¹⁵⁰

These results suggest that if the Georgia Supreme Court is, in fact, restricting the universe of potentially similar cases to cases in which a penalty trial occurred, that practice could explain a substantial proportion of the death case bias that we have observed in the court's appendices. Furthermore, these results create serious doubts about the legality of employing a penalty trial requirement in connection with the comparative review process, at least in jurisdictions in which only a relatively small proportion of capital convictions result in a penalty trial.¹⁵¹

c. Limited technology

Another explanation for the discrepancies between the results of our analyses and the Georgia Supreme Court's sentence review decisions may simply be the court's reliance on a manual system for storing information about prior cases and the absence of efficient procedures for retrieving similar cases. A computerized data set and improved procedures for (a) identifying the similar case selection criteria, and (b) ensuring a comprehensive search for all similar cases, perhaps by making greater use of the Court's Assistant for Proportionality Review, would greatly facilitate the court's ability to identify all similar cases.

d. The Georgia court's universe of potentially similar cases

For the purpose of our analyses of the sixty-eight death sentence cases in our study, we employed the same universe of potentially similar cases as does the Georgia Supreme Court. To achieve this result, we defined the parameters of the universe of potentially similar cases, as does the Georgia Supreme Court, in accordance with the following criteria:

- (1) The universe consists of capital cases decided under both the pre- and post-*Furman* penalty statutes.
- (2) The universe is limited only to those cases in which the defendant appeals to the Georgia Supreme Court.¹⁵²

¹⁵⁰ The rates were higher when the universe of cases was limited to those that advanced to a penalty trial.

¹⁵¹ The policy was unsuccessfully challenged in *State v. Mercer*, 618 S.W.2d at 20-22 (Seiler, J., dissenting). It has not been addressed, however, by the Georgia Supreme Court. *See also infra* note 173 and accompanying text.

¹⁵² The Georgia statute authorizes the Georgia Supreme Court to consider unappealed cases in GA. CODE ANN. § 27-2537(f), but the court does not regularly do so.

(3) Cases in which the jury imposed a death sentence which, on appeal, the Georgia court vacated on procedural grounds are classified as death sentence cases for comparative purposes.¹⁵³

Because we employed a universe of potentially similar cases constructed within the framework of these rules, they make no contribution to the observed discrepancies between the results of our analyses and the Georgia court's sentencing review decisions. Nevertheless, by defining the relevant universe of potentially similar cases in accordance with these criteria, the Georgia Supreme Court may have further biased its sentencing review process in favor of finding that death sentences under review are not excessive or disproportionate. Indeed, in *Gregg v. Georgia*¹⁵⁴ the defendant challenged two of these selection criteria for this very reason. In this section we report the results of analyses designed to test the effects of these three rules.

In *Gregg v. Georgia*, the defendant unsuccessfully challenged the Georgia Supreme Court's policy of considering pre-*Furman* cases as part of its death sentence review process. The United States Supreme Court sustained this policy on the ground that it was necessary "at the inception of the new procedure in the absence of any post-*Furman* cases available for comparison."¹⁵⁵ To test the effect of this policy we compared perceived levels of excessiveness among the sixty-eight death sentence cases in our study when pre-*Furman* cases were included and excluded from the universe of potentially similar cases.¹⁵⁶ The results of this test suggest that, in general, the inclusion of the pre-*Furman* cases biases the results in the direction of finding that death sentences are not excessive or disproportionate, but that the magnitude of the bias is trivial.¹⁵⁷

In *Gregg*, the United States Supreme Court also sustained the Georgia Supreme Court's policy of considering only appealed cases on the ground that the Georgia court "has the authority to consider [unap-

¹⁵³ The Georgia court has never explicitly addressed this issue. An examination of the court's appendices, however, indicates that the court makes no distinction between prior death sentence cases in which the death sentence was vacated on procedural grounds and death sentence cases in which the sentence was affirmed as not excessive or disproportionate.

¹⁵⁴ *Gregg v. Georgia*, 428 U.S. 153 (1976).

¹⁵⁵ *Id.* at 205 n.56.

¹⁵⁶ The hypothesis that the inclusion of pre-*Furman* cases in the comparative sentence review would bias the results is based upon the assumption that many death sentences imposed during the pre-*Furman* period were comparatively excessive. Consequently, including those cases in the analysis creates a risk of skewing the observed sentencing patterns identified in the comparative sentence review. Whether that skewing effect would necessarily contribute to the death sentence case bias is not, however, self-evident. There were a substantial number of highly aggravated pre-*Furman* life cases which would probably result in a death sentence today. The presence of these cases in the analysis increases the likelihood that pre-*Furman* life cases will be identified as similar to a post-*Furman* death sentence case undergoing a proportionality review.

¹⁵⁷ Table 12 below shows the results of this comparison.

pealed] cases."¹⁵⁸ The Georgia court has itself justified this practice by asserting that the appealed cases "represent a sufficient cross section of similar cases upon which an adequate comparative review can be made."¹⁵⁹ Our analysis indicates that limiting the pool of potentially similar cases to only appealed cases does introduce a pro-death sentence

TABLE 12

Average Death Sentencing Frequencies Among Similar Appealed Cases When Pre-*Furman* Cases are Included and Excluded from the Analysis, Controlling for the Predicted Likelihood of Receiving a Death Sentence

<u>A</u>	<u>B</u>	<u>C</u>	<u>D</u>
Predicted Likelihood of Receiving a Death Sentence from 1 (lowest) to 8 (highest) ^a	Pre and Post <i>Furman</i> Appealed Cases	Post- <i>Furman</i> Appealed Cases	Disparity (Col.B-Col.C)
	Death-Sentencing Rate and Sample Size	Death-Sentencing Rate and Sample Size	
1	.0 (0/23)	.0 (0/20)	.0
2	.02 (3/182)	.0 (0/151)	.02
3	.07 (8/109)	.07 (7/101)	.0
4	.22 (14/64)	.21 (11/52)	.01
5	.44 (20/46)	.39 (16/41)	.05
6	.83 (29/35)	.81 (26/32)	.02
7	.69 (11/16)	.67 (10/15)	.02
8	.96 (26/27)	.96 (26/27)	.0

^a See *supra* note 98 and accompanying text for a description of the index underlying this scale.

In individual cases, however, the impact may be significant. In an alternative analysis, not reported here, which used the salient factors method of identifying similar cases, we found that in two of 68 cases analyzed, the inclusion of the pre-*Furman* cases substantially affected the results to the defendant's disadvantage. In the first case there was a 27 percentage point disparity in the results and in the second case it was 41 points. Overall, however, the results of the salient features analysis showed that the inclusion of the pre-*Furman* cases in the analysis gave defendants a slight (two percentage points) advantage. Any effect from the use of pre-*Furman* cases can be expected to decline as time passes and the number of post-*Furman* cases increases in proportion to the number of pre-*Furman* cases. Eventually we expect the court will limit its universe strictly to post-*Furman* cases.

¹⁵⁸ *Gregg v. Georgia*, 428 U.S. at 205 n.56.

¹⁵⁹ *Ross v. State*, 233 Ga. 361, 366, 211 S.E.2d 356, 359 (1974). The expectation that the exclusion of nonappealed cases would bias the results of proportionality review has two foundations. First, although there is an appeal in every case in which a judgment of death is entered, appeals occur in only 69% of life cases. The pool of potentially similar cases, therefore, reflects a sampling rate of 1.00 for death sentence cases, but only .69 for life sentence cases. Consequently, groups of similar cases drawn from this universe of appealed cases may systematically underrepresent life cases. This underrepresentation is likely to occur even if, as the Georgia Supreme Court has asserted, the appealed life cases are a representative sample of all life sentence cases. To obtain an unskewed picture of the death-sentencing rate among groups of similar cases that have been appealed, good practice would call for weighting the appealed life cases to account for the lower appeal rate, *i.e.*, each appealed life case would stand for more than a single case in the calculation of death-sentencing frequencies.

bias, but the degree of bias is not large.¹⁶⁰

To our knowledge, no defendant has as yet challenged the Georgia Supreme Court's practice of classifying as a death sentence case, for the purpose of comparative sentence review, cases in which the court has vacated death sentences on procedural grounds. Because the court reverses on procedural grounds over twenty percent of the death sentences it reviews (and nearly thirty percent of the death sentences among the less aggravated cases), it seems likely that this practice would tend to overstate the presence of death sentence cases in the universe of potentially similar cases.¹⁶¹ Our analysis is consistent with this expectation.¹⁶² It indicates that this classification policy does increase the proportion of death sentence cases in the pool of potentially similar cases, thus favoring a finding that subsequent death sentences are not excessive or disproportionate. Furthermore, when compared to the results when one classifies vacated death sentence cases as life cases, the impact is substantial. However, if one excludes vacated death sentence cases from the analysis altogether, the impact is not significant.

Thus, it appears that these three policies, which the Georgia court employs when defining the universe of potentially similar cases, do contribute to some degree to a pro-death sentence bias in the sentence re-

¹⁶⁰ Table 13 below presents death-sentencing rates controlling for the predicted likelihood of receiving a death sentence.

TABLE 13

Death-Sentencing Frequencies Among Similar Cases When Unappealed Cases are Included and Excluded from the Analysis, Controlling for the Predicted Likelihood of Receiving a Death Sentence			
<u>A</u>	<u>B</u>	<u>C</u>	<u>D</u>
Predicted Likelihood of Receiving a Death Sentence from 3 (lowest) to 8 (highest) ^a	Appealed and Unappealed Cases	Only Appealed Cases	Disparity (Col.C-Col.B)
3	.07 (9/136)	.07 (7/101)	.0
4	.14 (12/87)	.21 (11/52)	.07
5	.33 (17/51)	.39 (16/41)	.06
6	.74 (26/35)	.81 (26/32)	.07
7	.67 (10/15)	.67 (10/15)	.0
8	.96 (26/27)	.96 (26/27)	.0

^a See *supra* note 98 and accompanying text for a description of the index underlying this scale. Levels 1 & 2 are omitted from the scale because no death sentences were imposed among cases at those levels.

¹⁶¹ The possibility exists, therefore, that some death sentence cases considered in the comparative sentence review are themselves comparatively excessive. The inclusion of such cases in the analysis may unjustifiably increase the frequency of death sentences among the cases found to be similar to the death case under review.

¹⁶² Tables 14 and 15 below show the results of the analysis.

view process. Furthermore, any one of these policies could have a substantial impact in any individual case. Consequently, we would question whether the adoption of these policies is justified despite the possible savings in terms of expense or administrative convenience.

TABLE 14

Death-Sentencing Frequencies Among Groups of Similar Appealed Cases When Death Sentence Cases Earlier Reversed by the Court on Procedural Grounds are Treated as Death Cases and When They are Treated as Life Cases			
<u>A</u>	<u>B</u>	<u>C</u>	<u>D</u>
Predicted Likelihood of Receiving a Death Sentence from 3 (lowest) to 8 (highest) ^a	All Death Sentence Cases Included in the Analysis Without Regard to Outcome of the Appeal	Death Cases Reversed on Procedural Grounds Treated as Life Cases	Disparity (Col.B-Col.C)
3	.07 (7/101)	.04 (4/101)	.03
4	.21 (11/52)	.14 (7/52)	.08
5	.39 (16/41)	.29 (12/41)	.10
6	.81 (26/32)	.72 (23/32)	.10
7	.67 (10/15)	.53 (8/15)	.14
8	.96 (26/27)	.74 (20/27)	.22

^a See *supra* note 98 and accompanying text for a description of the index underlying this scale. Levels 1 & 2 are omitted from the scale because no death sentences were imposed among cases at those levels.

TABLE 15

Death-Sentencing Frequencies Among Groups of Similar Appealed Cases When Death Sentence Cases Earlier Reversed by the Court on Procedural Grounds are Included and Excluded from the Analysis			
<u>A</u>	<u>B</u>	<u>C</u>	<u>D</u>
Predicted Likelihood of Receiving a Death Sentence from 3 (lowest) to 8 (highest) ^a	All Death Sentence Cases Included in the Analysis	Death Sentence Cases in Which the Death Sentence Was Earlier Reversed on Procedural Grounds are Excluded From the Analysis	Disparity (Col.B-Col.C)
3	.07 (7/101)	.04 (4/98)	.03
4	.21 (11/52)	.15 (7/48)	.06
5	.39 (16/41)	.32 (12/37)	.07
6	.81 (26/32)	.79 (23/29)	.04
7	.67 (10/15)	.62 (8/13)	.06
8	.96 (26/27)	.95 (20/21)	.01

^a See *supra* note 98 and accompanying text for a description of the index underlying this scale. Levels 1 & 2 are omitted from the scale because no death sentences were imposed among cases at those levels.

V. CONCLUSION

In *Gregg v. Georgia*, the United States Supreme Court emphasized the importance of Georgia's post-*Furman* system of sentence review in capital cases as a safeguard against comparatively excessive death sentences. In the words of Justice Stewart, the Georgia Supreme Court's review process should ensure that no person "sentenced to die by the action of an aberrant jury will suffer a sentence of death."¹⁶³ The Court reemphasized its view of the constitutional importance of the appellate review process in the recent decision of *Zant v. Stephens*.¹⁶⁴ The purpose of this study was to assess the manner in which the Georgia Supreme Court has actually performed this function, particularly with respect to sixty-eight death sentence cases which the court reviewed and affirmed between 1973 and 1979.

A. SUMMARY OF FINDINGS

We found first that Georgia's post-*Furman* death-sentencing system continues to impose death sentences which a variety of measures we employed identify as presumptively excessive.¹⁶⁵ Second, the Georgia Supreme Court has never vacated a death sentence imposed in a murder case on the grounds that it was excessive or disproportionate because of the infrequency of death sentencing among similar cases.¹⁶⁶ Third, based on our measures, relatively few of the sixty-eight death sentences in our sample that the Georgia court affirmed as neither "excessive or disproportionate" and that we analyzed for evidence of excessiveness would qualify as presumptively evenhanded.¹⁶⁷ To be sure, we did find some evidence to support the hypothesis that the Georgia Supreme Court reverses capital convictions or vacates death sentences on procedural grounds at a higher rate in cases involving arguably excessive death sentences.¹⁶⁸ But this form of *de facto* comparative sentence review is not sufficient to overcome the discrepancy between the court's sentence review decisions and the results of our analysis.

¹⁶³ *Gregg v. Georgia*, 428 U.S. at 195.

¹⁶⁴ 103 S. Ct. 2733 (1983).

¹⁶⁵ See *supra* notes 78-106 and accompanying text for a description of the data and the measures of comparative excessiveness. See *supra* notes 107-17 for a discussion of the standard used to determine whether death sentences are presumptively excessive or evenhanded, and see *supra* notes 118-33 and accompanying text for evidence of the frequency of presumptively excessive death sentences in Georgia's death-sentencing system.

¹⁶⁶ See *supra* notes 133-35 and accompanying text for a description of the Georgia court's record on comparative sentence review. The court has vacated two death sentences on the ground of excessiveness or disproportionality but not because of an infrequency of death sentencing among similar cases. See *supra* notes 133-34.

¹⁶⁷ See *supra* text accompanying notes 123-26.

¹⁶⁸ See *supra* notes 136-38 and accompanying text.

Our findings also suggest that the Georgia Supreme Court invariably fails to vacate death sentences as excessive or disproportionate for a very simple reason: when identifying other cases as "similar" to the death sentence case under review for comparative purposes, the court almost exclusively chooses cases that resulted in death sentences; very rarely does the court include in its appendices of similar cases comparable cases which resulted in a life sentence.¹⁶⁹

We also attempted to discover the reasons for this systematic exclusion of life sentence cases. We analyzed the impact of several rules or conventions that the court sometimes appeared to employ when prescribing the universe of potentially similar cases and when selecting cases deemed to be comparable to a particular death sentence case from that universe.¹⁷⁰ We found that the court's practice of including pre-*Furman* cases in the universe of potentially similar cases tended to overstate the proportion of death sentence cases in that universe, but that the magnitude of the impact was not great. Similarly, we found that the effects of limiting the universe of potentially similar cases to appealed cases and of classifying death sentence cases vacated on procedural grounds as death sentence cases for comparative purposes were much the same; they tended to encourage the overselection of death sentence cases, but the extent of impact was not substantial. Certainly, by themselves, these practices do not explain the marked variations between the Georgia Supreme Court's sentencing review decisions and the results of our analyses.

Other possible explanations that we considered, but were unable to evaluate statistically, were the impact of the court's rudimentary method of selecting similar cases and the possibility that at least some author judges employ a "precedent-seeking" approach to the selection process rather than the more comprehensive "frequency" approach characteristic of a true comparative sentence review.¹⁷¹ It appears, however, that the most likely explanation for the Georgia court's tendency systematically to overselect death sentence cases is a policy of considering only cases in which a penalty trial occurred. Such a policy would exclude from the universe of potentially similar cases nearly two-thirds of all the life sentence cases appealed to the court. Our tests indicate, moreover, that such a policy would explain a substantial portion of the disparity between the cases listed as "similar" in the court's appendices and those identified as "similar" by our alternate methods. Consequently, we suspect that the penalty trial requirement, to which the

¹⁶⁹ See *supra* note 135 and accompanying text.

¹⁷⁰ See *supra* notes 152-62 and accompanying text.

¹⁷¹ See *supra* notes 142-43 and accompanying text.

Georgia Supreme Court's opinions sometimes refer, may be the chief cause for the overselection of death sentence cases as "similar" and the systematic failure of the court to identify any death sentence as excessive or disproportionate.¹⁷²

B. EIGHTH AMENDMENT IMPLICATIONS

These findings raise serious questions about the actual operation of Georgia's post-*Furman* death-sentencing statute. Our data suggest that Georgia's death-sentencing system has continued to impose the type of inconsistent, arbitrary death sentences that the United States Supreme Court condemned in *Furman v. Georgia*. More importantly, the Georgia Supreme Court's sentence review process has failed to identify and to vacate such death sentences—the very function upon which the opinions in *Zant v. Stephens* and *Gregg* placed such emphasis. Consequently, one could question whether, as applied, Georgia's system for imposing capital punishment operates in the consistent, evenhanded manner required by the eighth amendment.

Moreover, the Georgia Supreme Court has made no effort to articulate a principled method for selecting cases deemed to be similar for comparative purposes. Because the overall death-sentencing rate is quite low in death-eligible cases, the statutory aggravating circumstances which make those cases death-eligible do not serve to distinguish between cases resulting in death sentences and all life sentence cases. In *Godfrey v. Georgia*, the United States Supreme Court vacated a death sentence imposed under the Georgia statute because, as interpreted, the statutory aggravating circumstance involved in the case did not serve to distinguish the death sentence case on appeal from other life sentence cases on any principled basis.¹⁷³ If Georgia's comparative sentence review process is to serve as a satisfactory means of preventing arbitrary or excessive death sentences within the group of murder cases for which capital punishment is legally permissible, the Georgia Supreme Court must perform that function in a consistent, principled manner. The obscure, possibly inconsistent methods by which the court presently selects cases deemed to be "similar" for purposes of sentence review do not appear to satisfy those criteria.

To the extent that the Georgia court's failure to conduct efficacious comparative sentence reviews results from a policy of considering only penalty trial cases, an additional constitutional question emerges. In *Gregg*, the United States Supreme Court rejected the notion that the existence of prosecutorial discretion in capital cases made the Georgia

¹⁷² See *supra* notes 144-51 and accompanying text.

¹⁷³ See *supra* note 86.

death-sentencing statute unconstitutional.¹⁷⁴ The Court reached this conclusion in part because it assumed that prosecutors had no control over the sentencing process once a capital conviction was obtained and that all defendants convicted of a capital crime would be sentenced by a judge or jury in a penalty trial.¹⁷⁵ Indeed, such an assumption is essential to the Court's further conclusion that the Georgia Supreme Court's sentence review process could ensure consistent, evenhanded sentencing in all capital cases.¹⁷⁶

In fact, however, Georgia prosecutors exercise absolute discretion over whether the cases of death-eligible defendants convicted of murder will advance to a penalty trial, and in practice the majority of such defendants do not undergo a penalty trial.¹⁷⁷ In this respect alone, the assumptions upon which the United States Supreme Court decided *Gregg* and the actual operation of the Georgia system differ in a constitutionally significant fashion. Moreover, if the Georgia Supreme Court, by virtue of a penalty trial only policy, ignores in its comparative sentence reviews the large majority of murder cases in which no penalty trial is held, these frequent exercises of prosecutorial discretion are insulated against even indirect appellate review.¹⁷⁸

Finally, our analyses suggest that Georgia's death-sentencing system is tainted by the influence of arbitrary and capricious factors, notably the victim's race and the place where the defendant is prosecuted.¹⁷⁹

C. THE FUTURE OF COMPARATIVE SENTENCE REVIEW

Various courts have suggested recently that the type of comparative sentence review which the Georgia statute contemplates imposes an impossible task upon state supreme courts.¹⁸⁰ We disagree. Our experience in this study has persuaded us that a properly conducted sentence review procedure may be demanding, but is not impossible. We also believe that state supreme courts, like that of Georgia, can make prudent use of systematic, empirically-based procedures to improve their own review processes. Because they are computer-assisted, these methods will facilitate the selection of all presumptively similar cases. They

¹⁷⁴ *Gregg v. Georgia*, 428 U.S. at 199-200, 200 n.50.

¹⁷⁵ See *supra* note 146 and accompanying text.

¹⁷⁶ Because prosecutorial decisions not to seek, and jury decisions not to impose, death sentences are not reviewable, comparative sentence review provides the only vehicle for ensuring that defendants sentenced to death receive the same treatment as similarly situated defendants whom prosecutors decide to insulate from the death penalty.

¹⁷⁷ See *supra* note 129 and accompanying text.

¹⁷⁸ See *supra* note 145 and accompanying text.

¹⁷⁹ See *supra* note 130 and accompanying text.

¹⁸⁰ See *supra* note 97; see also *Blake v. Zant*, 513 F. Supp. at 818-26; *State v. Copeland*, — S.C. —, —, 300 S.E.2d 63, 77 (1982).

will permit appellate courts to focus upon the frequency of death sentences among cases deemed to be similar (and the legal issues attendant to that inquiry) and will free individual jurists from the burden of subjectively deciding whether individual death sentences are justified by the facts of the case.¹⁸¹

Quantitative, computer-assisted methods are also especially useful because they permit the systematic identification of presumptively similar cases from a variety of perspectives. When different quantitative methods yield the same general group of presumptively similar cases, as is likely to happen in connection with highly aggravated review cases, a court can be confident that the similar cases it seeks are among those identified by the different measures. If, however, different methods yield inconsistent results or substantially different groups of arguably similar cases, the court will be on notice to conduct its review process with greater caution.¹⁸²

We emphasize, however, that while a computer can facilitate an effective and comprehensive comparative sentence review, it only serves as a point of departure. The computer can assist a court in identifying other cases that are presumptively similar (because, for example, they involve common factual elements), but the final determination of comparability will require an examination of the case summaries and records of the cases identified by the computer as presumptively similar.¹⁸³

Such a systematic approach to comparative sentence review will increase the reviewing court's confidence in its choice of "similar" cases. It should also facilitate the resolution of the legal issues associated with

¹⁸¹ The guided discretion of death-sentencing procedures approved by the United States Supreme Court are designed to allocate the exercise of subjective judgments of death worthiness to the sentencing authority, usually a jury. The role of the appellate court is to police these manifestations of contemporary community standards to ensure consistency in the process required by the eighth amendment. This is not to suggest that this policing function requires no subjective judgments. Both the specification of the case characteristics used to identify similar cases and the determination of how infrequently a death sentence must occur among similar cases before it is held excessive or disproportionate clearly involve subjective value judgments. But these judgments are of a quite different order than the determination that a death-sentenced defendant's moral culpability does or does not justify his death sentence or that the aggravating circumstances of the case outweigh the mitigating circumstances.

¹⁸² In the 68 cases analyzed in this study with three different measures of comparative excessiveness there were only 12 cases in which the death-sentencing rate among similar cases was higher than .50 for all three measures.

¹⁸³ Our experience also indicates that an effective comparative review process can be conducted without any computer assistance even in jurisdictions with caseloads the magnitude of Georgia's. Moreover, tabulations of the type shown in Appendix B, which can give the court an overview of the state's entire death-sentencing process, can be constructed through a manual sort of cases.

the definition of the universe of potentially similar cases, the identification of the proper factors to use for selecting similar cases, and the interpretation of death-sentencing frequencies in individual cases. In this fashion, the reviewing court can enhance the rationality and consistency of the sentence review process, thereby ensuring greater consistency in the entire death-sentencing system.

APPENDIX A

	Page
Review Case 955	733
Review Case 495	735
Review Case 621	737
Review Case 991	738
Review Case 512	739
Review Case 810	741
Review Case 586	742
Review Case 627	743
Review Case 672	745
Review Case 628	746
Review Case 581	747
Review Case 593	748
Review Case 704	749
Review Case 992	751

REVIEW CASE 955

The defendant was a 39-year-old male with a long criminal record. While on probation, he kidnapped and killed without provocation a female nurse who was unknown to him. He beat her and then shot her in the head.

APPENDIX CASES

Case D56

The 24-year-old male defendant shot and killed a 58-year-old male and a 66-year-old female who surprised him as he was burglarizing their home. As they pleaded for their lives, he beat the male with a baseball bat and then shot both of them in the head.

Case 071

While holding up a service station, the 20-year-old AWOL male shot the attendant five times. The defendant had committed other crimes before (car theft) and after (aggravated assault) the murder.

Case 074

The defendant bound and killed two victims in their home while com-

mitting robbery. He was later characterized as depraved of mind after laughing about the murders.

Case 246

While escaped from a federal prison, the 20-year-old male defendant killed the victim with a shot to the head during a holdup. He also sexually molested and shot a witness who survived.

Case 264

While intoxicated, the defendant and his coperpetrator shot a storekeeper five times in the head and body without provocation during the course of a holdup. A partial motive included revenge.

Case 279

After hitchhiking a ride, the defendant robbed, shot, and killed the middle-aged driver and his friend at a roadside stop.

Case 307

Having a prior record of assault, the defendant kidnapped a stranger, attempted rape, and then murdered the victim. Possible premeditation was involved.

Case 362

Characterized as having a mental disorder, the defendant forced entry and robbed his victim's home. He terrorized the family and shot the victim, who died the following day. Premeditation may or may not have been involved.

Case 450

The defendant is of low intelligence and was 18 years old at the time. After drinking and smoking marijuana, the defendant carried out a premeditated scheme to get a car by stabbing a 17-year-old male acquaintance 18 times with a butcher knife. Afterward, the defendant tried to obtain reward money by giving information to the victim's parents.

Case 459

The 24-year-old defendant and his two coperpetrators beat and then used a shotgun to shoot the elderly proprietor of a gas-convenience store, as the victim pled for his life. A bystander was seriously injured, another was robbed, and the shots narrowly missed a milkman who happened on the scene.

Case 488

The 22-year-old defendant shot to death and then robbed a middle-aged cab driver in a premeditated scheme.

Case 491

While traveling through the state, the defendant shot and killed the 14-year-old son of a grocery store owner (after provocation) in the course of armed robbery. After shooting the son, the defendant then suggested raping the mother and shot her three times, leaving her for dead.

Case 510

The 19-year-old male defendant kidnapped and then shot a 50-year-old woman for the sport of it.

Case 512

The 22-year-old male defendant committed an armed robbery of a gas station, and the next day he beat and killed a 22-year-old female store clerk with a hammer after stabbing her seven times.

Case 553

The defendant sodomized and strangled two 7-year-old boys, killing both.

Case 576

With premeditation, the defendant bound, strangled, tortured, and robbed two elderly victims, both of whom died.

Case 577

The mentally unbalanced defendant killed a stranger who reminded him of his stepmother.

Case 579

In a premeditated scheme, the defendant bound, tortured, strangled, and robbed two elderly victims, both of whom died.

Case 559

While drunk, the 23-year-old male defendant shot a male victim in his house during an attempted robbery (after the victim fired at the defendant). Afterwards, the defendant confessed and cooperated with authorities.

REVIEW CASE 495

The 30-year-old male defendant, diagnosed as a paranoid schizophrenic, kidnapped the victim who had been lured from his house to aid another whom the defendant had wounded. Without provocation, the defendant shot the kidnappee as he pled for his life, and took his personal belongings. The defendant was then arrested after a shoot-out with the police.

*APPENDIX CASES**Case 074*

The defendant bound and killed two victims in their home while committing robbery. He was later characterized as depraved of mind after laughing about the murders.

Case 307

Having a prior record of assault, the defendant kidnapped a stranger, attempted rape, and then murdered the victim. Possible premeditation was involved.

Case 362

Characterized as having a mental disorder, the defendant forced entry and robbed his victim's home. He terrorized the family and shot the victim, who died the following day. Premeditation may or may not have been involved.

Case 553

The defendant sodomized and strangled two 7-year-old boys, killing both.

Case 576

With premeditation, the defendant bound, strangled, tortured, and robbed two elderly victims, both of whom died.

Case 577

The mentally unbalanced defendant killed a stranger who reminded him of his stepmother.

Case 420

The young defendant, characterized as a sexual deviant, raped and murdered his victim without premeditation.

Case 494

The defendant, a disgruntled bank customer, beat and shot a bank vice-president in his home. Later, the defendant sought to extort money from the bank with a hostage claim.

Case 551

The defendant sexually tortured and mutilated a woman he forcefully brought home from a bar. Motive: "To teach that 'nigger-lover' a lesson."

Case 571

While on a crime spree, the defendant beat, robbed, and killed three elderly victims in their homes.

Case 578

The mentally retarded defendant killed his ex-wife after beating her and carving initials in her body.

Case 581

Seeking revenge, the sexually frustrated defendant threw his girlfriend's 2-year-old child off a bridge.

Case 627

The defendant and his copetrator robbed, bound, gagged, beat, and shot the victim five times before burying him alive to prevent their identification. Defense claimed insanity and the use of drugs; neither was substantiated by experts. Prosecution claimed the defendant confessed.

Case 628

The defendant and his copetrator robbed, bound, gagged, beat, and shot the victim five times before burying him alive to prevent their iden-

tification. Defense claimed insanity and the use of drugs; neither was substantiated by experts. Prosecution claimed the defendant confessed.

REVIEW CASE 621

The defendant and his coperpetrator beat a 74-year-old barber to death with a knife and a hammer in the course of armed robbery. The victim sustained massive head wounds and died 3½ months later. There was considerable debate whether either or both committed the crime.

APPENDIX CASES

Case 074

The defendant bound and killed two victims in their home while committing robbery. He was later characterized as depraved of mind after laughing about the murders.

Case 279

After hitchhiking a ride, the defendant robbed, shot, and killed the middle-aged driver and his friend at a roadside stop.

Case 307

Having a prior record of assault, the defendant kidnapped a stranger, attempted rape, and then murdered the victim. Possible premeditation was involved.

Case 362

Characterized as having a mental disorder, the defendant forced entry and robbed his victim's home. He terrorized the family and shot the victim, who died the following day. Premeditation may or may not have been involved.

Case 450

The defendant was of low intelligence and was 18 years old at the time. After drinking and smoking marijuana, the defendant carried out a premeditated scheme to get a car by stabbing a 17-year-old male acquaintance 18 times with a butcher knife. Afterwards, the defendant tried to obtain reward money by giving information to the victim's parents.

Case 459

The 24-year-old defendant and his two coperpetrators beat and then used a shotgun to shoot the elderly proprietor of a gas-convenience store, as the victim pled for his life. A bystander was seriously injured, another was robbed, and the shots narrowly missed a milkman who happened on the scene.

Case 488

The 22-year-old defendant shot to death and then robbed a middle-aged cab driver in a premeditated scheme.

Case 491

While traveling through the state, the defendant shot and killed the 14-year-old son of a grocery store owner (after provocation) in the course of an armed robbery. After shooting the son, the defendant then suggested raping the mother and shot her three times, leaving her for dead.

Case 510

The 19-year-old male defendant kidnapped and then shot a 50-year-old woman for the sport of it.

Case 576

With premeditation, the defendant bound, strangled, tortured, and robbed two elderly victims, both of whom died.

Case 571

While on a crime spree, the defendant beat, robbed, and killed three elderly victims in their homes.

REVIEW CASE 991

The defendant beat to death with a hammer a 74-year-old barber while robbing his shop. In the attack, the elderly barber was pitted against two young men.

*APPENDIX CASES**Case 074*

The defendant bound and killed two victims in their home while committing robbery. He was later characterized as depraved of mind after laughing about the murders.

Case 279

After hitchhiking a ride, the defendant robbed, shot, and killed the middle-aged driver and his friend at a roadside stop.

Case 307

Having a prior record of assault, the defendant kidnapped a stranger, attempted rape, and then murdered the victim. Possible premeditation was involved.

Case 362

Characterized as having a mental disorder, the defendant forced entry and robbed his victim's home. He terrorized the family and shot the victim, who died the following day. Premeditation may or may not have been involved.

Case 450

The defendant was of low intelligence and was 18 years old at the time. After drinking and smoking marijuana, the defendant carried out a premeditated scheme to get a car by stabbing a 17-year-old male acquaint-

tance 18 times with a butcher knife. Afterwards, the defendant tried to obtain reward money by giving information to the victim's parents.

Case 459

The 24-year-old defendant and his two coperpetrators beat and then used a shotgun to shoot the elderly proprietor of a gas-convenience store, as the victim pled for his life. A bystander was seriously injured, another was robbed, and the shots narrowly missed a milkman who happened on the scene.

Case 488

The 22-year-old defendant shot to death and then robbed a middle-aged cab driver in a premeditated scheme.

Case 491

While traveling through the state, the defendant shot and killed the 14-year-old son of a grocery store owner (after provocation) in the course of an armed robbery. After shooting the son, the defendant then suggested raping the mother and shot her three times, leaving her for dead.

Case 510

The 19-year-old male defendant kidnapped and then shot a 50-year-old woman for the sport of it.

Case 512

The 22-year-old male defendant committed armed robbery of a gas station, and the next day he beat and killed a 22-year-old female store clerk with a hammer after stabbing her seven times.

Case 576

With premeditation, the defendant bound, strangled, tortured, and robbed two elderly victims, both of whom died.

Case 571

While on a crime spree, the defendant beat, robbed, and killed three elderly victims in their homes.

Case 621

The defendant and his coperpetrator beat a 74-year-old barber to death with a knife and a hammer in the course of armed robbery. The victim sustained massive head wounds and died 3½ months later. There was considerable debate whether either or both committed the crime.

REVIEW CASE 512

The 22-year-old male defendant committed armed robbery of a gas sta-

tion, and the next day he beat and killed a 22-year-old female store clerk with a hammer after stabbing her seven times.

APPENDIX CASES

Case 074

The defendant bound and killed two victims in their home while committing robbery. He was later characterized as depraved of mind after laughing about the murders.

Case 279

After hitchhiking a ride, the defendant robbed, shot, and killed the middle-aged driver and his friend at a roadside stop.

Case 307

Having a prior record of assault, the defendant kidnapped a stranger, attempted rape, and then murdered the victim. Possible premeditation was involved.

Case 362

Characterized as having a mental disorder, the defendant forced entry and robbed his victim's home. He terrorized the family and shot the victim, who died the following day. Premeditation may or may not have been involved.

Case 450

The defendant was of low intelligence and was 18 years old at the time. After drinking and smoking marijuana, the defendant carried out a premeditated scheme to get a car by stabbing a 17-year-old male acquaintance 18 times with a butcher knife. Afterwards, the defendant tried to obtain reward money by giving information to the victim's parents.

Case 459

The 24-year-old defendant and his two coperpetrators beat and then used a shotgun to shoot the elderly proprietor of a gas-convenience store, as the victim pled for his life. A bystander was seriously injured, another was robbed, and the shots narrowly missed a milkman who happened on the scene.

Case 488

The 22-year-old defendant shot to death and then robbed a middle-aged cab driver in a premeditated scheme.

Case 491

While traveling through the state, the defendant shot and killed the 14-year-old son of a grocery store owner (after provocation) in the course of an armed robbery. After shooting the son, the defendant then suggested raping the mother and shot her three times, leaving her for dead.

Case 510

The 19-year-old male defendant kidnapped and then shot a 50-year-old woman for the sport of it.

Case 576

With premeditation, the defendant bound, strangled, tortured, and robbed two elderly victims, both of whom died.

Case 559

While drunk, the 23-year-old male defendant shot a male victim in his house during an attempted robbery (after the victim fired at the defendant). Afterwards, the defendant confessed and cooperated with authorities.

Case 571

While on a crime spree, the defendant beat, robbed and killed three elderly victims in their homes.

Case 265

Along with five other escaped convicts, the defendants systematically shot and killed six family members who were unknown to them. The victims were robbed, and one female victim was raped and mutilated before being killed.

Case 266

Along with five other escaped convicts, the defendants systematically shot and killed six family members who were unknown to them. The victims were robbed, and one female victim was raped and mutilated before being killed.

Case 267

Along with five other escaped convicts, the defendants systematically shot and killed six family members who were unknown to them. The victims were robbed, and one female victim was raped and mutilated before being killed.

REVIEW CASE 810

The defendant, having prior burglary convictions, together with his coperpetrator, beat a 60-year-old female and her bedridden mother. After the beating, the victims were stabbed in the chest with a butcher knife. After the killings the defendant robbed the house, laughing about the incident. The burglary was premeditated, but the killings were not.

*APPENDIX CASES**Case 074*

The defendant bound and killed two victims in their home while committing robbery. He was later characterized as depraved of mind after laughing about the murders.

Case 362

Characterized as having a mental disorder, the defendant forced entry and robbed his victim's home. He terrorized the family and shot the victim, who died the following day. Premeditation may or may not have been involved.

Case 510

The 19-year-old male defendant kidnapped and then shot a 50-year-old woman for the sport of it.

Case 576

With premeditation, the defendant bound, strangled, tortured, and robbed two elderly victims, both of whom died.

Case 579

In a premeditated scheme, the defendant bound, tortured, strangled, and robbed two elderly victims, both of whom died.

Case 420

The young defendant, characterized as a sexual deviant, raped and murdered his victim without premeditation.

Case 571

While on a crime spree, the defendant beat, robbed, and killed three elderly victims in their homes.

REVIEW CASE 586

The 18-year-old mildly retarded and sexually frustrated defendant beat and killed two victims and raped a third.

*APPENDIX CASES**Case 074*

The defendant bound and killed two victims in their home while committing robbery. He was later characterized as depraved of mind after laughing about the murders.

Case 279

After hitchhiking a ride, the defendant robbed, shot, and killed the middle-aged driver and his friend at a roadside stop.

Case 553

The defendant sodomized and strangled two 7-year-old boys, killing both.

Case 576

With premeditation, the defendant bound, strangled, tortured, and robbed two elderly victims, both of whom died.

Case 579

In a premeditated scheme, the defendant bound, tortured, strangled, and robbed two elderly victims, both of whom died.

Case 551

The defendant sexually tortured and mutilated a woman he forcefully brought home from a bar. Motive: "To teach that 'nigger-lover' a lesson."

Case 265

Along with five other escaped convicts, the defendants systematically shot and killed six family members who were unknown to them. The victims were robbed, and one female victim was raped and mutilated before being killed.

Case 266

Along with five other escaped convicts, the defendants systematically shot and killed six family members who were unknown to them. The victims were robbed, and one female victim was raped and mutilated before being killed.

Case 267

Along with five other escaped convicts, the defendants systematically shot and killed six family members who were unknown to them. The victims were robbed, and one female victim was raped and mutilated before being killed.

Case 064

The 34-year-old female defendant hired agents to kill her ex-husband for the insurance money. Both the ex-husband and his second wife were killed.

Case 573

Presumably desiring money and valuables, the 23-year-old male defendant killed two victims in a secluded area.

Case 980

The 23-year-old male defendant carried out the premeditated murder of a politically prominent church figure, shooting him in the head and the chest. He also shot to death other church members in the crowded church.

REVIEW CASE 627

The defendant and his coperpetrator robbed, bound, gagged, beat, and shot the victim five times before burying him alive to prevent their identification. Defense claimed insanity and the use of drugs; neither was substantiated by experts. Prosecution claimed the defendant confessed.

*APPENDIX CASES**Case 074*

The defendant bound and killed two victims in their home while com-

mitting robbery. He was later characterized as depraved of mind after laughing about the murders.

Case 307

Having a prior record of assault, the defendant kidnapped a stranger, attempted rape, and then murdered the victim. Possible premeditation was involved.

Case 362

Characterized as having a mental disorder, the defendant forced entry and robbed his victim's home. He terrorized the family and shot the victim, who died the following day. Premeditation may or may not have been involved.

Case 553

The defendant sodomized and strangled two 7-year-old boys, killing both.

Case 576

With premeditation, the defendant bound, strangled, tortured, and robbed two elderly victims, both of whom died.

Case 577

The mentally unbalanced defendant killed a stranger who reminded him of his stepmother.

Case 420

The young defendant, characterized as a sexual deviant, raped and murdered his victim without premeditation.

Case 494

The defendant, a disgruntled bank customer, beat and shot a bank vice-president in his home. Later, the defendant sought to extort money from the bank with a hostage claim.

Case 551

The defendant sexually tortured and mutilated a woman he forcefully brought home from a bar. Motive: "To teach that 'nigger-lover' a lesson."

Case 571

While on a crime spree, the defendant beat, robbed, and killed three elderly victims in their homes.

Case 578

The mentally retarded defendant killed his ex-wife after beating her and carving initials in her body.

Case 581

Seeking revenge, the sexually frustrated defendant threw his girlfriend's 2-year-old child off a bridge.

Case 586

The 18-year-old mildly retarded and sexually frustrated defendant beat and killed two victims and raped a third.

REVIEW CASE 672

The defendant, a 24-year-old male with a felony record, robbed a store and then abducted an 18-year-old female clerk. With his codefendant, they raped her, shot her twice, and then mutilated the body.

*APPENDIX CASES**Case 074*

The defendant bound and killed two victims in their home while committing robbery. He was later characterized as depraved of mind after laughing about the murders.

Case 279

After hitchhiking a ride, the defendant robbed, shot, and killed the middle-aged driver and his friend at a roadside stop.

Case 307

Having a prior record of assault, the defendant kidnapped a stranger, attempted rape, and then murdered the victim. Possible premeditation was involved.

Case 362

Characterized as having a mental disorder, the defendant forced entry and robbed his victim's home. He terrorized the family and shot the victim, who died the following day. Premeditation may or may not have been involved.

Case 450

The defendant was of low intelligence and was 18 years old at the time. After drinking and smoking marijuana, the defendant carried out a premeditated scheme to get a car by stabbing a 17-year-old male acquaintance 18 times with a butcher knife. Afterwards the defendant tried to obtain reward money by giving information to the victim's parents.

Case 459

The 24-year-old defendant and his two coperpetrators beat and then used a shotgun to shoot the elderly proprietor of a gas-convenience store, as the victim pled for his life. A bystander was seriously injured, another was robbed, and the shots narrowly missed a milkman who happened on the scene.

Case 488

The 22-year-old defendant shot to death and then robbed a middle-aged cab driver in a premeditated scheme.

Case 491

While traveling through the state, the defendant shot and killed the 14-year-old son of a grocery store owner (after provocation) in the course of an armed robbery. After shooting the son, the defendant then suggested raping the mother and shot her three times, leaving her for dead.

Case 553

The defendant sodomized and strangled two 7-year-old boys, killing both.

Case 559

While drunk, the 23-year-old male defendant shot a male victim in his house during an attempted robbery (after the victim fired at the defendant). Afterwards, the defendant confessed and cooperated with authorities.

Case 420

The young defendant, characterized as a sexual deviant, raped and murdered his victim without premeditation.

REVIEW CASE 628

The defendant and his coperpetrator robbed, bound, gagged, beat, and shot the victim five times before burying him alive to prevent their identification. Defense claimed insanity and the use of drugs; neither was substantiated by experts. Prosecution claimed the defendant confessed.

*APPENDIX CASES**Case 074*

The defendant bound and killed two victims in their home while committing robbery. He was later characterized as depraved of mind after laughing about the murders.

Case 307

Having a prior record of assault, the defendant kidnapped a stranger, attempted rape, and then murdered the victim. Possible premeditation was involved.

Case 362

Characterized as having a mental disorder, the defendant forced entry and robbed his victim's home. He terrorized the family and shot the victim, who died the following day. Premeditation may or may not have been involved.

Case 553

The defendant sodomized and strangled two 7-year-old boys, killing both.

Case 576

With premeditation, the defendant bound, strangled, tortured, and robbed two elderly victims, both of whom died.

Case 577

The mentally unbalanced defendant killed a stranger who reminded him of his stepmother.

Case 420

The young defendant, characterized as a sexual deviant, raped and murdered his victim without premeditation.

Case 494

The defendant, a disgruntled bank customer, beat and shot a bank vice-president in his home. Later, the defendant sought to extort money from the bank with a hostage claim.

Case 551

The defendant sexually tortured and mutilated a woman he forcefully brought home from a bar. Motive: "To teach that 'nigger-lover' a lesson."

Case 571

While on a crime spree, the defendant beat, robbed, and killed three elderly victims in their homes.

Case 578

The mentally retarded defendant killed his ex-wife after beating her and carving initials in her body.

Case 581

Seeking revenge, the sexually frustrated defendant threw his girlfriend's 2-year-old child off a bridge.

Case 586

The 18-year-old mildly retarded and sexually frustrated defendant beat and killed two victims and raped a third.

Case 627

The defendant and his coperpetrator robbed, bound, gagged, beat, and shot the victim five times before burying him alive to prevent their identification. Defense claimed insanity and the use of drugs; neither was substantiated by experts. Prosecution claimed the defendant confessed.

REVIEW CASE 581

Seeking revenge, the sexually frustrated defendant threw his girlfriend's 2-year-old child off a bridge.

*APPENDIX CASES**Case 510*

The 19-year-old male defendant kidnapped and then shot a 50-year-old woman for the sport of it.

Case 553

The defendant sodomized and strangled two 7-year-old boys, killing both.

Case 577

The mentally unbalanced defendant killed a stranger who reminded him of his stepmother.

Case 551

The defendant sexually tortured and mutilated a woman he forcefully brought home from a bar. Motive: "To teach that 'nigger-lover' a lesson."

Case 578

The mentally retarded defendant killed his ex-wife after beating her and carving initials in her body.

REVIEW CASE 593

The 22-year-old male defendant kidnapped two young girls and forced the older one (10 years old) to perform oral sex three times and then raped her. The younger girl (8 years old) escaped, but the defendant caught up with her by a creek and drowned her. Defendant was said to be unable to control his sexual impulses.

*APPENDIX CASES**Case 307*

Having a prior record of assault, the defendant kidnapped a stranger, attempted rape, and then murdered the victim. Possible premeditation was involved.

Case 491

While traveling through the state, the defendant shot and killed the 14-year-old son of a grocery store owner (after provocation) in the course of an armed robbery. After shooting the son, the defendant then suggested raping the mother and shot her three times, leaving her for dead.

Case 553

The defendant sodomized and strangled two 7-year-old boys, killing both.

Case 672

The defendant, a 24-year-old male with a felony record, robbed a store and then abducted an 18-year-old female clerk. With his codefendant, they raped her, shot her twice, and then mutilated her body.

Case 420

The young defendant, characterized as a sexual deviant, raped and murdered his victim without premeditation.

Case 581

Seeking revenge, the sexually frustrated defendant threw his girlfriend's 2-year-old child off a bridge.

Case 265

Along with five other escaped convicts, the defendants systematically shot and killed six family members who were unknown to them. The victims were robbed, and one female victim was raped and mutilated before being killed.

Case 266

Along with five other escaped convicts, the defendants systematically shot and killed six family members who were unknown to them. The victims were robbed, and one female victim was raped and mutilated before being killed.

Case 267

Along with five other escaped convicts, the defendants systematically shot and killed six family members who were unknown to them. The victims were robbed, and one female victim was raped and mutilated before being killed.

REVIEW CASE 704

The 36-year-old male defendant, with a history of psychiatric difficulty, held up a bar and killed, with three shots, an off-duty policeman who interrupted him. He then wounded the policeman's companion and kidnapped a bar employee who was the primary witness. The bar employee was not harmed.

*APPENDIX CASES**Case 074*

The defendant bound and killed two victims in their home while committing robbery. He was later characterized as depraved of mind after laughing about the murders.

Case 307

Having a prior record of assault, the defendant kidnapped a stranger, attempted rape, and then murdered the victim. Possible premeditation was involved.

Case 362

Characterized as having a mental disorder, the defendant forced entry and robbed his victim's home. He terrorized the family and shot the

victim, who died the following day. Premeditation may or may not have been involved.

Case 553

The defendant sodomized and strangled two 7-year-old boys, killing both.

Case 576

With premeditation, the defendant bound, strangled, tortured, and robbed two elderly victims, both of whom died.

Case 577

The mentally unbalanced defendant killed a stranger who reminded him of his stepmother.

Case 420

The young defendant, characterized as a sexual deviant, raped and murdered his victim without premeditation.

Case 494

The defendant, a disgruntled bank customer, beat and shot a bank vice-president in his home. Later, the defendant sought to extort money from the bank with a hostage claim.

Case 551

The defendant sexually tortured and mutilated a woman he forcefully brought home from a bar. Motive: "To teach that 'nigger-lover' a lesson."

Case 571

While on a crime spree, the defendant beat, robbed, and killed three elderly victims in their homes.

Case 578

The mentally retarded defendant killed his ex-wife after beating her and carving initials in her body.

Case 581

Seeking revenge, the sexually frustrated defendant threw his girlfriend's 2-year-old child off a bridge.

Case 627

The defendant and his coperpetrator robbed, bound, gagged, beat, and shot the victim five times before burying him alive to prevent their identification. Defense claimed insanity and the use of drugs; neither was substantiated by experts. Prosecution claimed the defendant confessed.

Case 628

The defendant and his coperpetrator robbed, bound, gagged, beat, and shot the victim five times before burying him alive to prevent their identification. Defense claimed insanity and the use of drugs; neither was substantiated by experts. Prosecution claimed the defendant confessed.

Case 495

The 30-year-old male defendant, diagnosed as a paranoid schizophrenic, kidnapped the victim who had been lured from his house to aid another whom the defendant had wounded. Without provocation, the defendant shot the kidnappee as he pled for his life, and took his personal belongings. The defendant was then arrested after a shoot-out with the police.

REVIEW CASE 992

The 17-year-old defendant together with coperpetrators kidnapped, robbed, and murdered a 64-year-old man. Upon abduction, the victim was forced into the trunk of a car, and as he pled for his life, the defendant shot the victim in the shoulder, and his coperpetrator shot him in the head with a double-barrelled shotgun. Defendant laughed at the incident and said the murder was racially motivated.

*APPENDIX CASES**Case 074*

The defendant bound and killed two victims in their home while committing robbery. He was later characterized as depraved of mind after laughing about the murders.

Case 307

Having a prior record of assault, the defendant kidnapped a stranger, attempted rape, and then murdered the victim. Possible premeditation was involved.

Case 362

Characterized as having a mental disorder, the defendant forced entry and robbed his victim's home. He terrorized the family and shot the victim, who died the following day. Premeditation may or may not have been involved.

Case 553

The defendant sodomized and strangled two 7-year-old boys, killing both.

Case 576

With premeditation, the defendant bound, strangled, tortured, and robbed two elderly victims, both of whom died.

Case 577

The mentally unbalanced defendant killed a stranger who reminded him of his stepmother.

Case 420

The young defendant, characterized as a sexual deviant, raped and murdered his victim without premeditation.

Case 494

The defendant, a disgruntled bank customer, beat and shot a bank vice-president in his home. Later, the defendant sought to extort money from the bank with a hostage claim.

Case 551

The defendant sexually tortured and mutilated a woman he forcefully brought home from a bar. Motive: "To teach that 'niggerlover' a lesson."

Case 571

While on a crime spree, the defendant beat, robbed, and killed three elderly victims in their homes.

Case 578

The mentally retarded defendant killed his ex-wife after beating her and carving initials in her body.

Case 581

Seeking revenge, the sexually frustrated defendant threw his girlfriend's 2-year-old child off a bridge.

Case 627

The defendant and his coperpetrator robbed, bound, gagged, beat, and shot the victim five times before burying him alive to prevent their identification. Defense claimed insanity and the use of drugs; neither was substantiated by experts. Prosecution claimed the defendant confessed.

Case 628

The defendant and his coperpetrator robbed, bound, gagged, beat, and shot the victim five times before burying him alive to prevent their identification. Defense claimed insanity and the use of drugs; neither was substantiated by experts. Prosecution claimed the defendant confessed.

APPENDIX B
DEATH SENTENCING FREQUENCIES AMONG
SUBGROUPS OF DEFENDANTS WHO KILLED
ONE VICTIM

KEY
 DEATH SENTENCE RATE
 $\frac{\# \text{ DEATH CASES}}{\# \text{ ALL CASES}}$

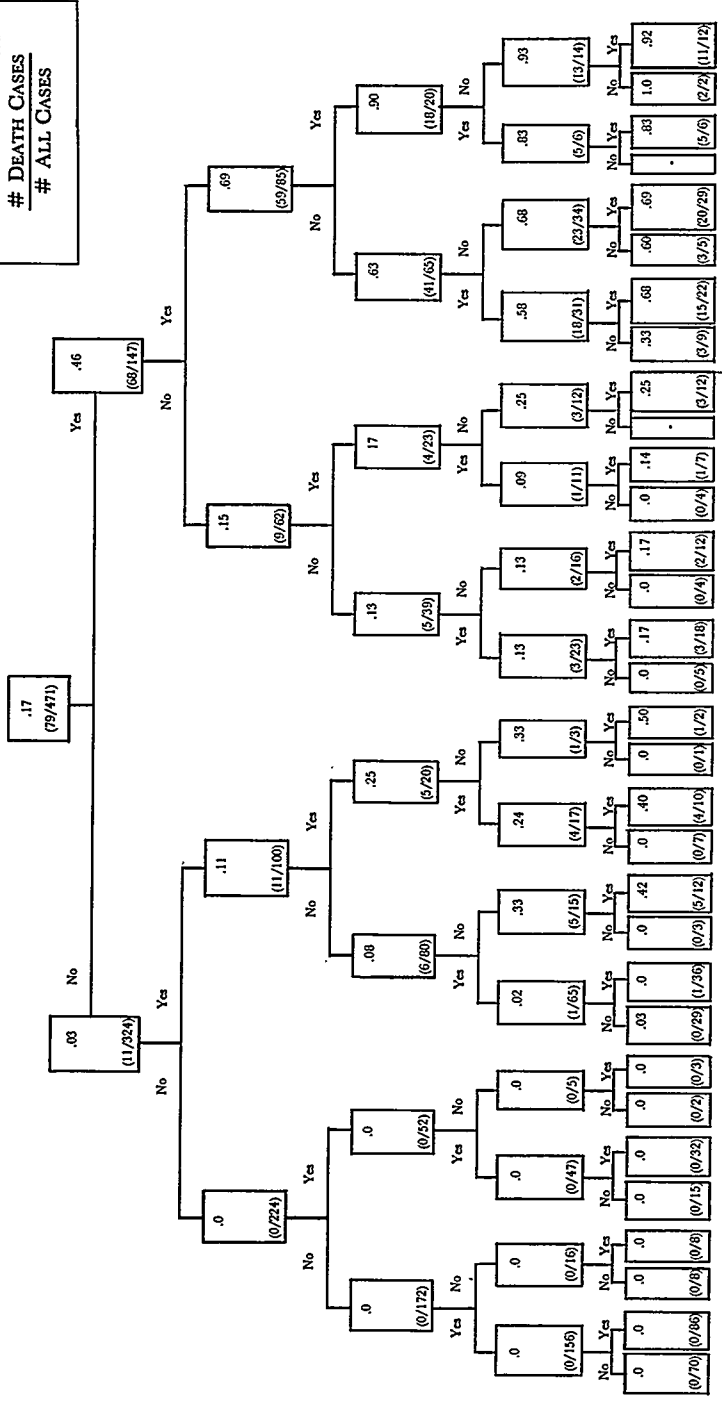

Serious
 Contemporaneous
 Offense

Serious
 Aggravating
 Circumstances

Prior
 Record

Mitigating
 Circumstances

Minor
 Aggravating
 Circumstances